

sciae

44 Avenue Paul Girard
10500 DIENVILLE
FRANCE

www.sciae.com

PRADO

INDICE A - 25/02/2019

PRADO 3615 MIROIR N°23 Réf: 18CC1711

PRADO 4381 MIROIR N°23 Réf: 18CD1711

NOTICE DE MONTAGE

ASSEMBLING INSTRUCTIONS

MONTAGEANLEIUNG

MANUAL DE MONTAJE

MONTAGEVOORSCHRIFT

ISTRUÇÕES DE MONTAGEM

ISTRUZIONI DI MONTAGGIO

ИНСТРУКЦИЯ ПО СБОРКЕ

Naputci za montažu

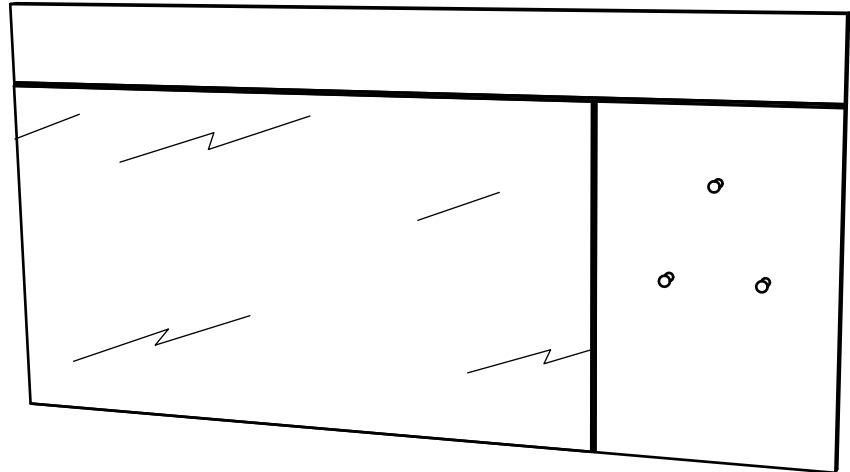

0H30

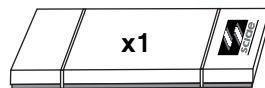

Package 1: 12,5 Kg

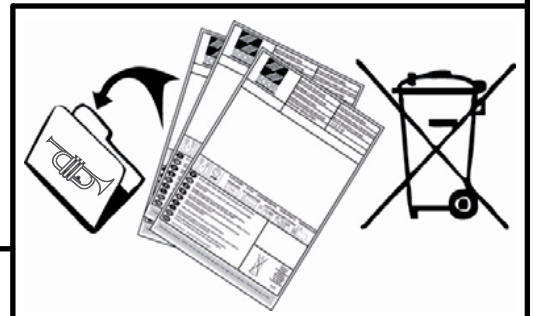

F POUR L'APRES-VENTE, RETOURNEZ AU MAGASIN AVEC CETTE NOTICE

GB FOR THE AFTER SALES, GO BACK TO THE SHOP WITH THIS ASSEMBLY INSTRUCTION

D WENDEN SIE SICH BITTE AN IHREN HANDLER UND GEBEN SIE IHM DIE KENNUMMER DES MOBELS UND DIE TEILNUMMER

E EN CASO DE SERVICIO POST-VENTA DEBEN DE VOLVER A LA TIENDA CON LAS INSTRUCCIONES DE MONTAJE

NL VOOR SERVICE NA VERKOOP, GA NAAR UW LEVERANCIER MET DEZE MONTAGE HANDLEIDING

P PARA O POS VENDA, VOLTE A LOJA COM ESTA FOLHA

I SERVIZIO POST VENDITA: E NECESSARIO PRESENTARSI SUL PUNTO VENDITA CON QUESTE ISTRUZIONI DI MONTAGGIO

RU ДЛЯ ПОСЛЕПРОДАЖНОГО ОБСЛУЖИВАНИЯ ПРОСЬБА ОБРАТИТЬСЯ В МАГАЗИН ПРЕДЪЯВИВ НАСТОЯЩУЮ ИНСТРУКЦИЮ ПО СБОРКЕ

HR U SLUČAJU REKLAMACIJE, VRATITE SE NA PRODAJNO MJESTO S OVIM UPUTAMA ZA MONTAŽU

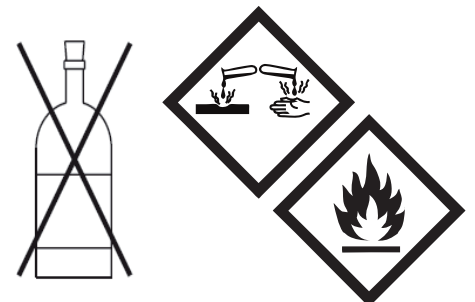
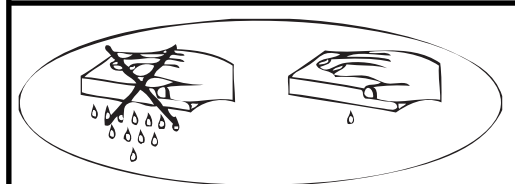

SCIAE se réserve le droit de modifier sans préavis tout ou partie de ses collections - Meuble vendu sans accessoire

FRANCAIS

Recommandations de démontage :

En cas de déménagement, il convient de procéder au démontage de votre meuble, en ôtant toute la visserie.

ENGLISH

Disassembly advices:

In case of moving, it is needed to dismantle the furniture removing the fittings.

DEUTSCH

Empfehlungen für die Demontage:

Bei Transport bitte alle Beschläge demontieren.

	+40°C +104°F	
	+15°C +59°F	

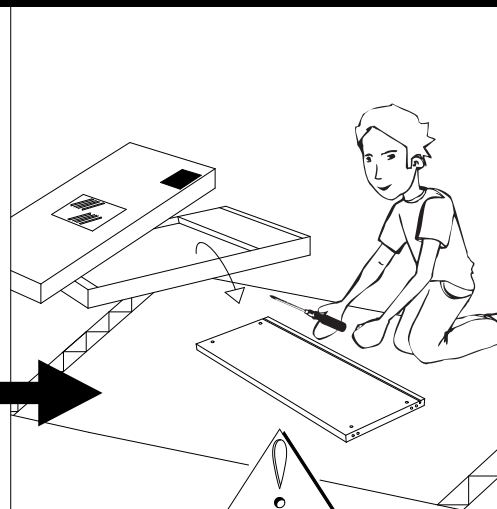
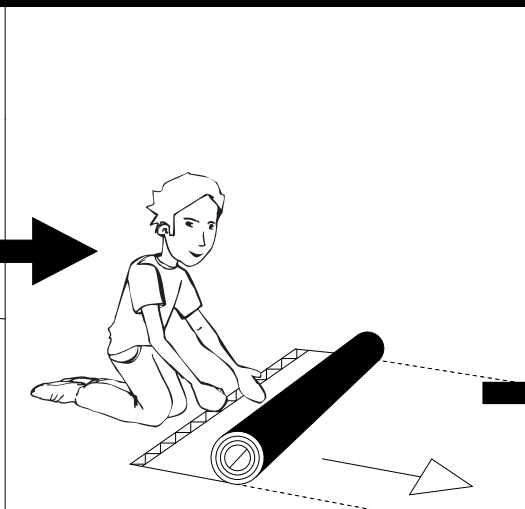
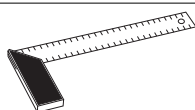
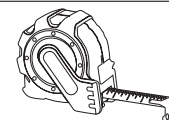
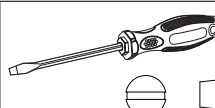
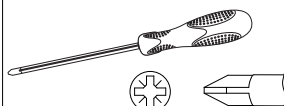
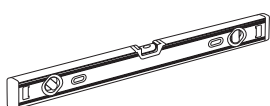
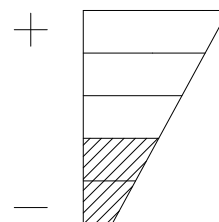
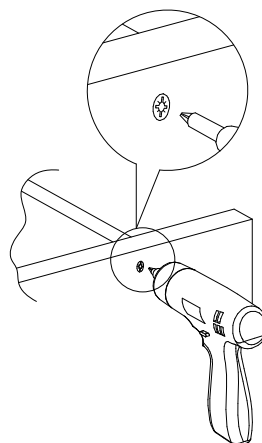
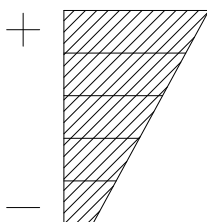
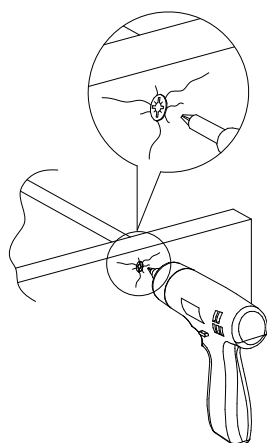
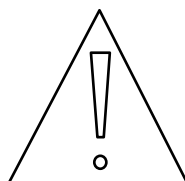
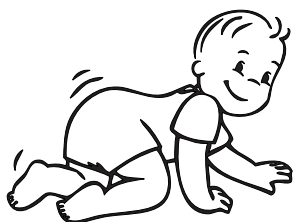



PRADO 3615:

Miroir composé de panneaux de particules revêtus papier blanc laqués blanc brillant.
Ajout de profils PVC Gris moonstone brillant et de 3 patères en plastique chrome brillant
L.120 cm - H.60 cm - P.2 cm.
A monter soi-même.

PRADO 4381:

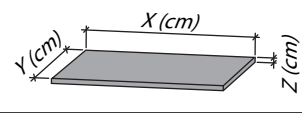
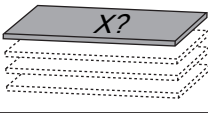
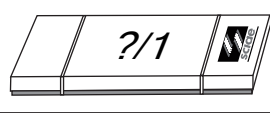
Miroir composé de panneaux de particules revêtus papier décor Oak endgrain.
Ajout de profils PVC Blanc mat et de 3 patères en plastique chrome brillant
L.120 cm - H.60 cm - P.2 cm.
A monter soi-même.

DESIGNATION		N°		
MIROIR	120 x 60 x 2	Z1		1

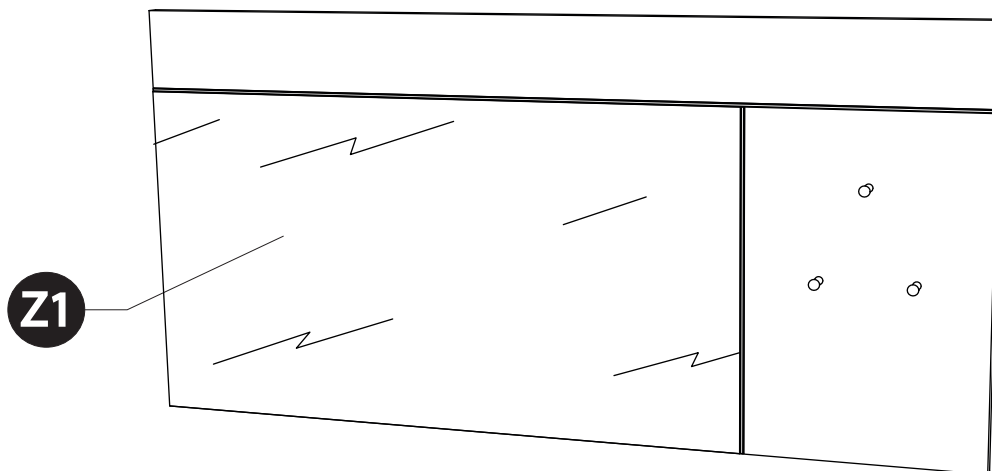
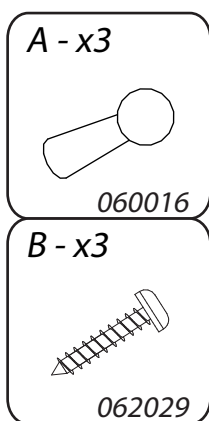

1

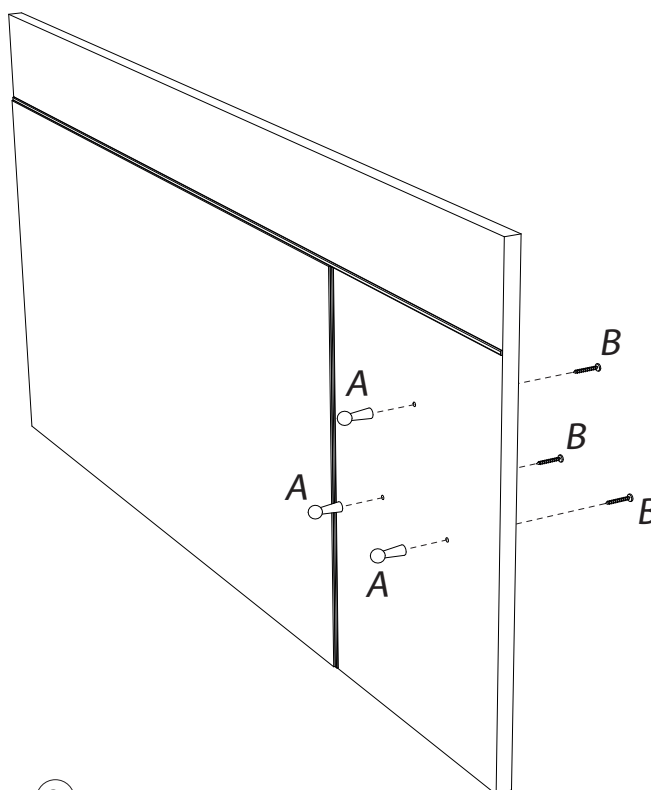
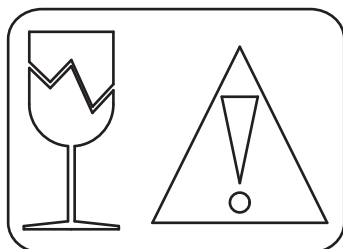
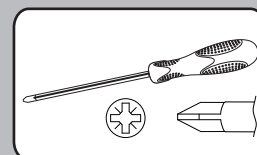
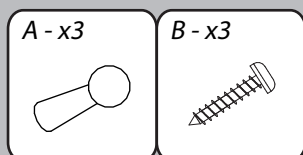

Il existe une grande diversité de types de murs ou cloisons, c'est la raison pour laquelle nous ne pouvons vous fournir le type exact de fixation. Il est nécessaire d'identifier le type de paroi à laquelle vous aller fixer ce produit afin de vous procurer les fixations appropriées. Voici quelques exemples de fixations conseillées pour:

LES MURS PLEINS

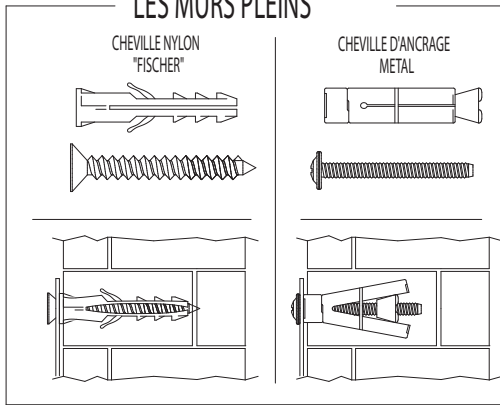

LES CLOISONS CREUSES

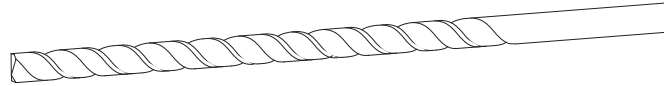
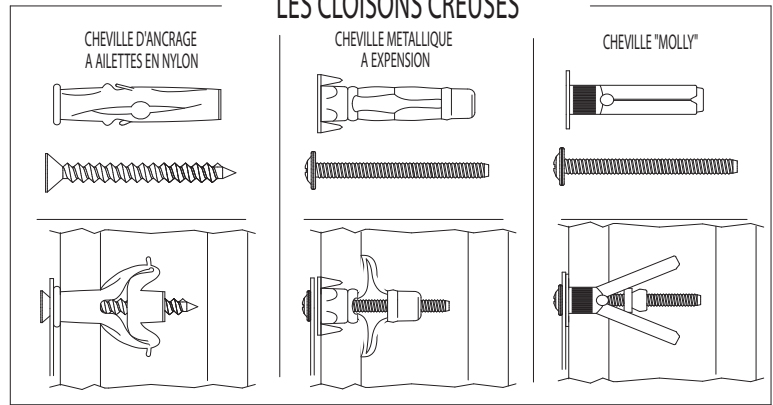

Utiliser une taille de forêt adaptée à la quincaillerie utilisée et au type de mur.

2

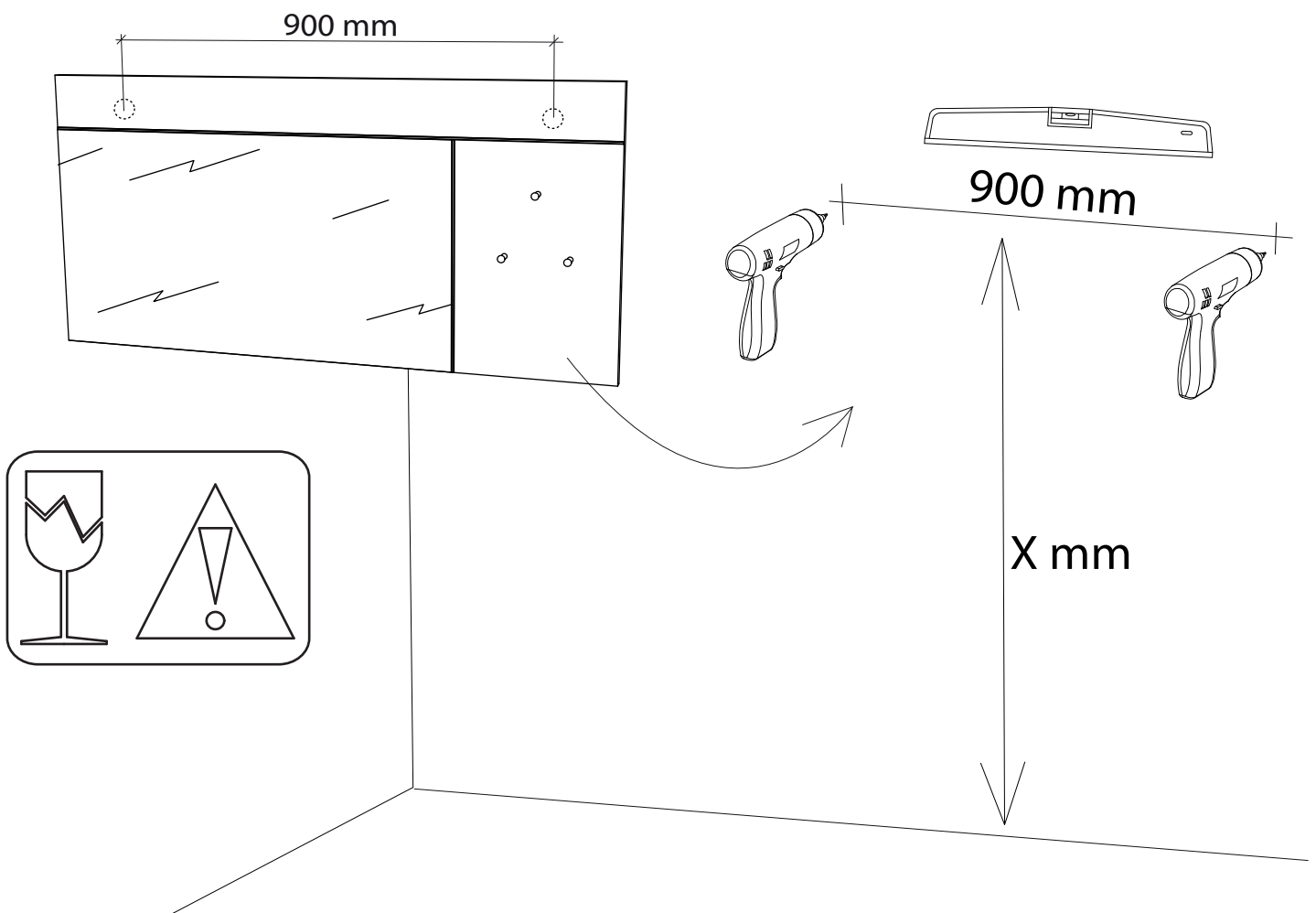
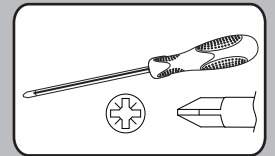
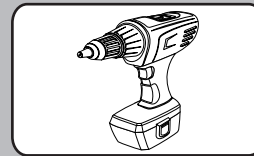

"Les meubles contenant des panneaux à base de bois (panneaux de particules, panneaux de fibres, contreplaqué...) peuvent émettre des substances polluantes dans l'air intérieur. Il est ainsi recommandé, après l'installation du meuble dans son logement, d'aérer fréquemment la pièce concernée pendant au moins quatre semaines afin de réduire son exposition aux polluants émis par le meuble."