



# STONE Couchtisch 83557...3

Nr 1/6



wyprodukowano dla / made for / produziert für  
**BEGA GRUPPE**  
 producent: **MEBLE OKMED POLAND**

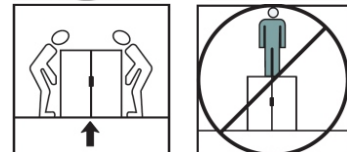
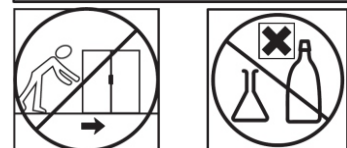
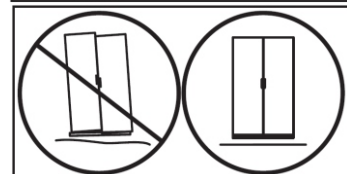
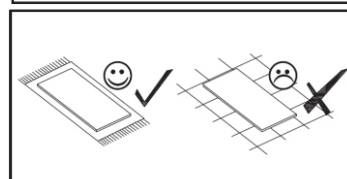
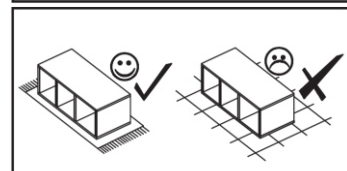
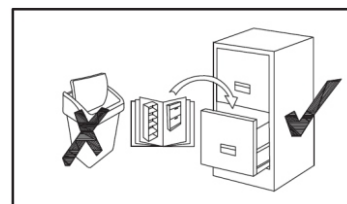
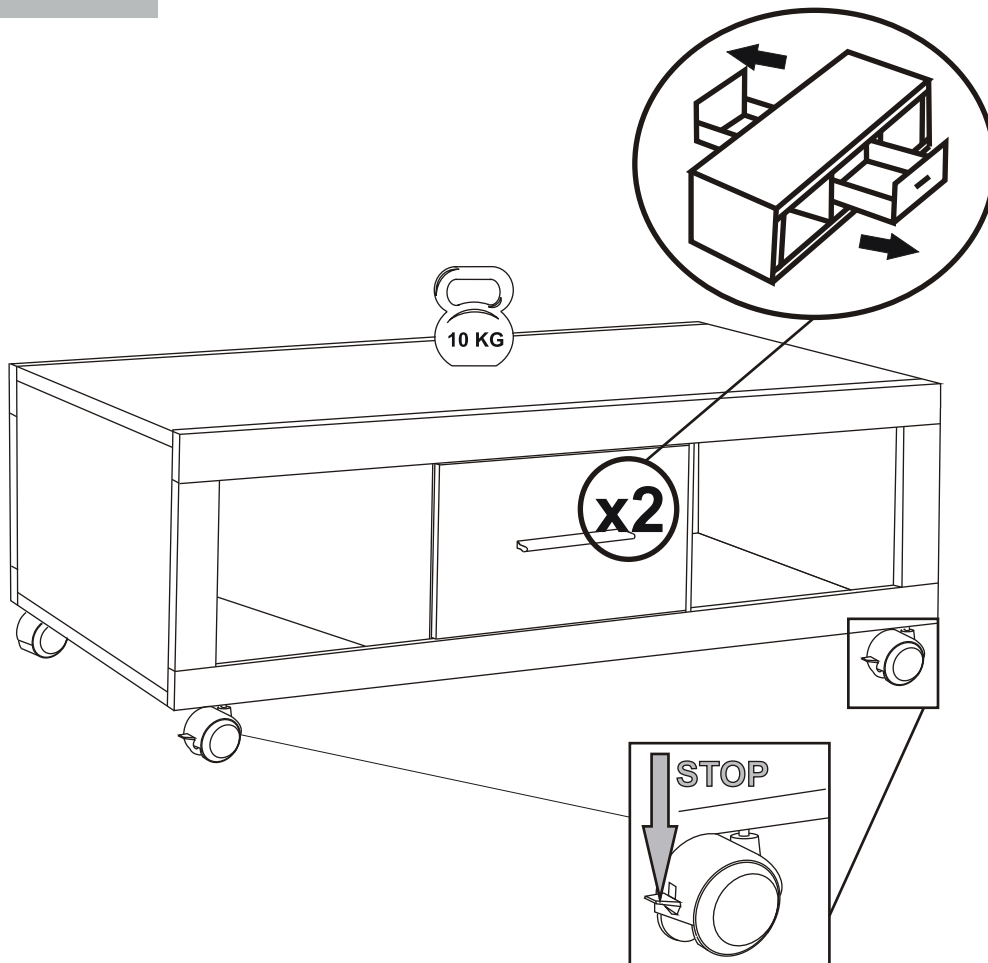
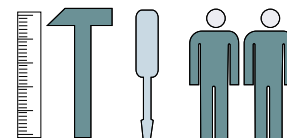

8	EL-STO-STO-2SZ-LIST-L/P-BE	16x60x315	x4
7	EL-STO-STO-2SZ-LIST-G/D-BE	16x60x1.153	x4
6	EL-STO-STO-2SZ-DACH-D-BE	16x1.152x568	x1
5	EL-STO-STO-2SZ-DACH-G-BE	16x1.152x568	x1
1	EL-STO-STO-2S-BOK-L-BE	16x403x568	x1
2	EL-STO-STO-2S-BOK-P-BE	16x403x568	x1
3	EL-STO-STO-2SZ-PRZEG-L-BI	16x403x567	x1
4	EL-STO-STO-2SZ-PRZEG-P-BI	16x403x567	x1
10	EL-STO-STO-2SZ-BOK-SZ-L-BI	16x395x100	x2
11	EL-STO-STO-2SZ-BOK-SZ-P-BI	16x395x100	x2
9	EL-STO-STO-2SZ-TYL-SZ-BI	16x277x84	x2
14	EL-STO-STO-2S-DNO-SZ-HDF-BI	3x400x290	x2
13	EL-STO-STO-2S-FRO-SZ-G-BI POŁ	16x340x308	x1
12	EL-STO-STO-2S-FRO-SZ-D-BI POŁ	16x340x308	x1

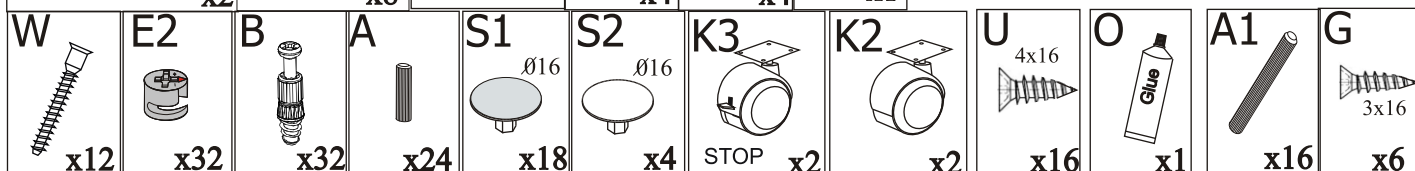
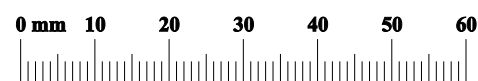
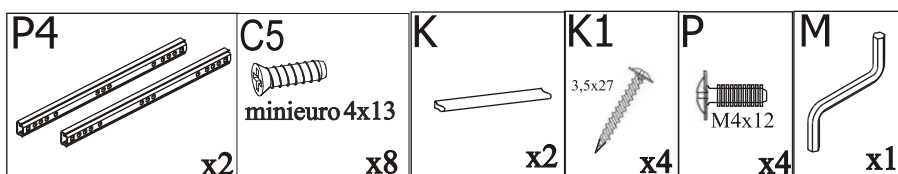

01

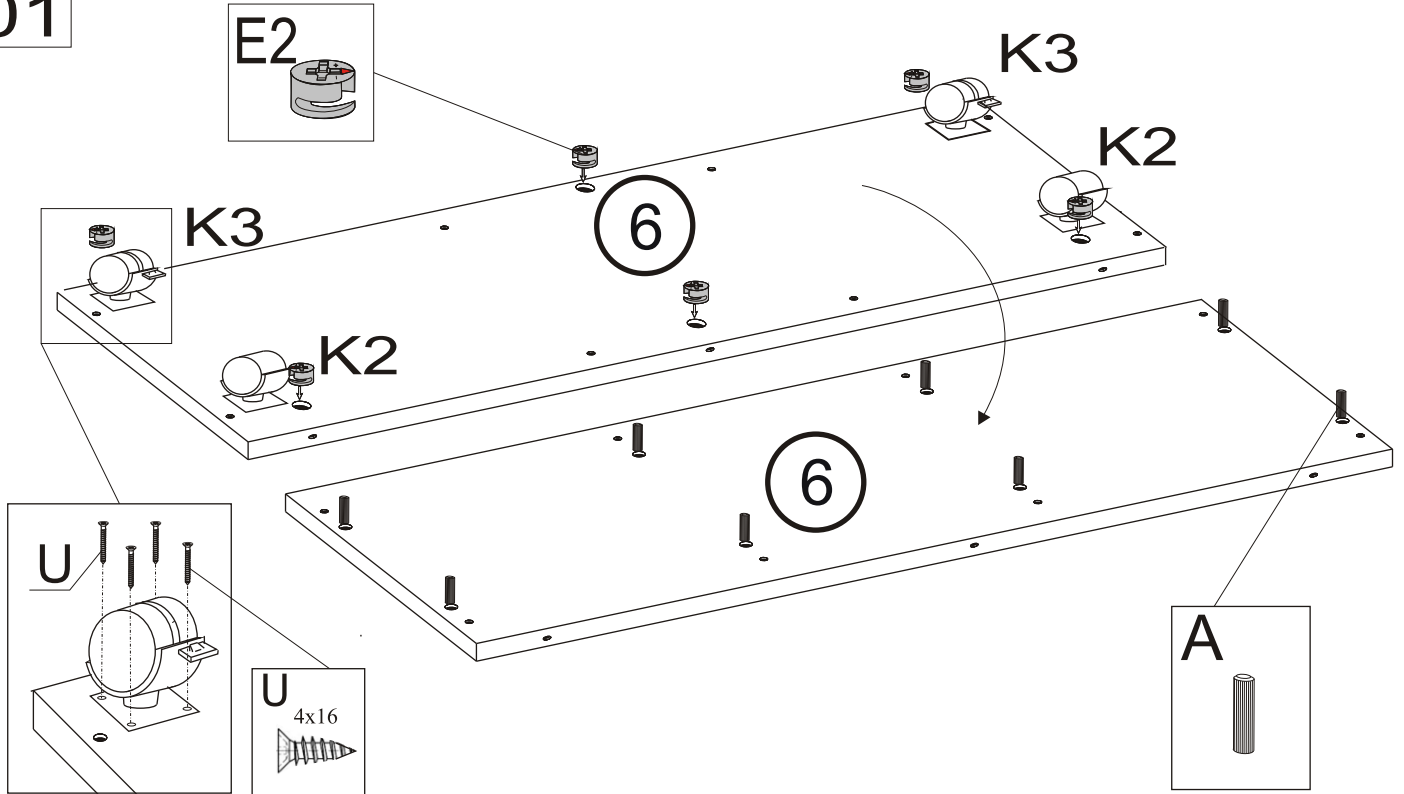

02

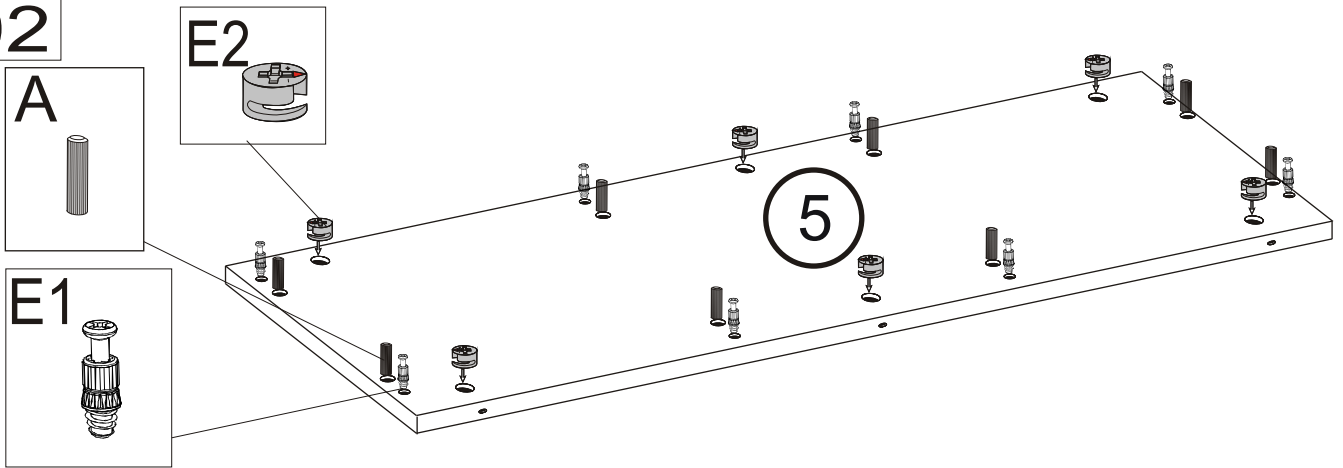

03

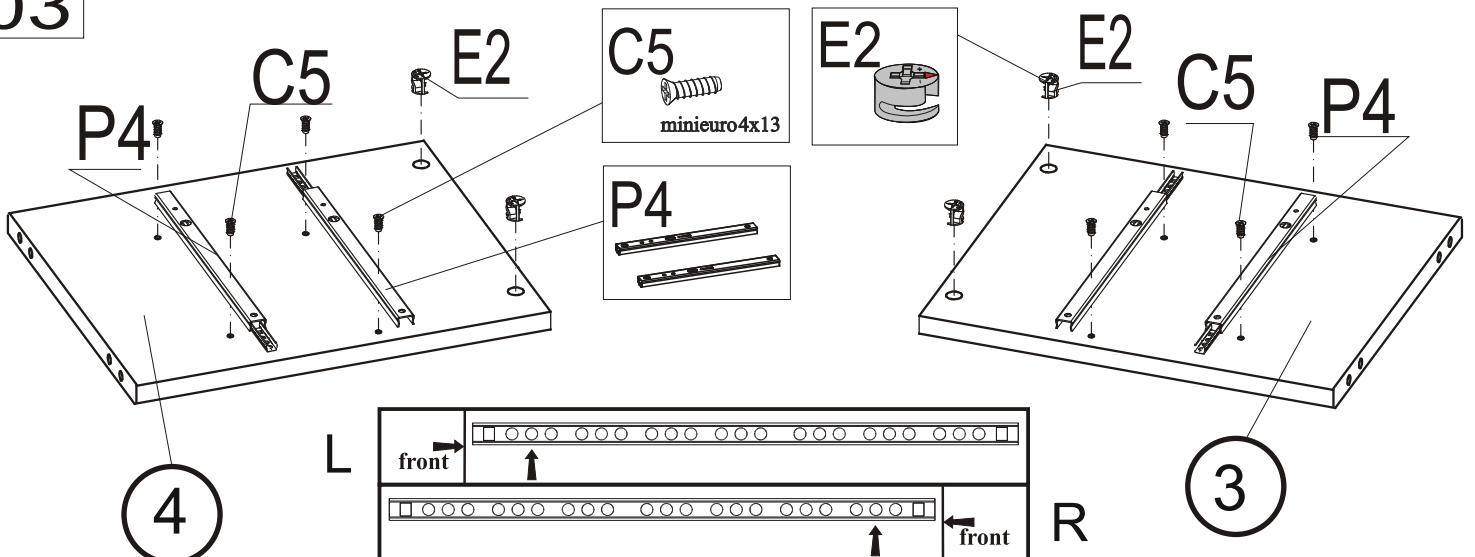

04

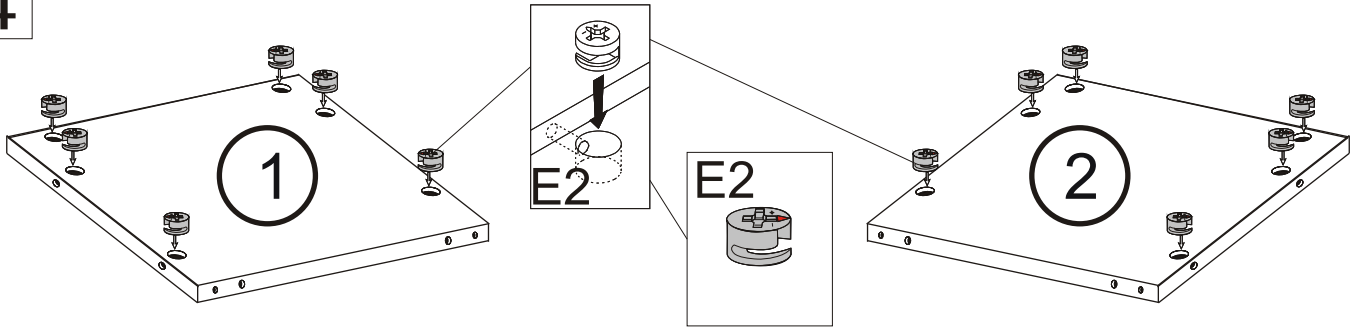

05

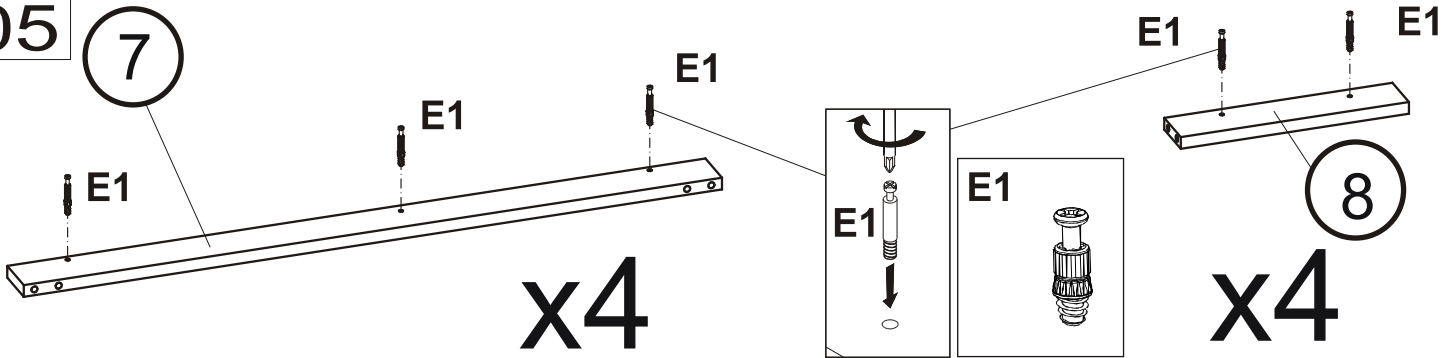

06

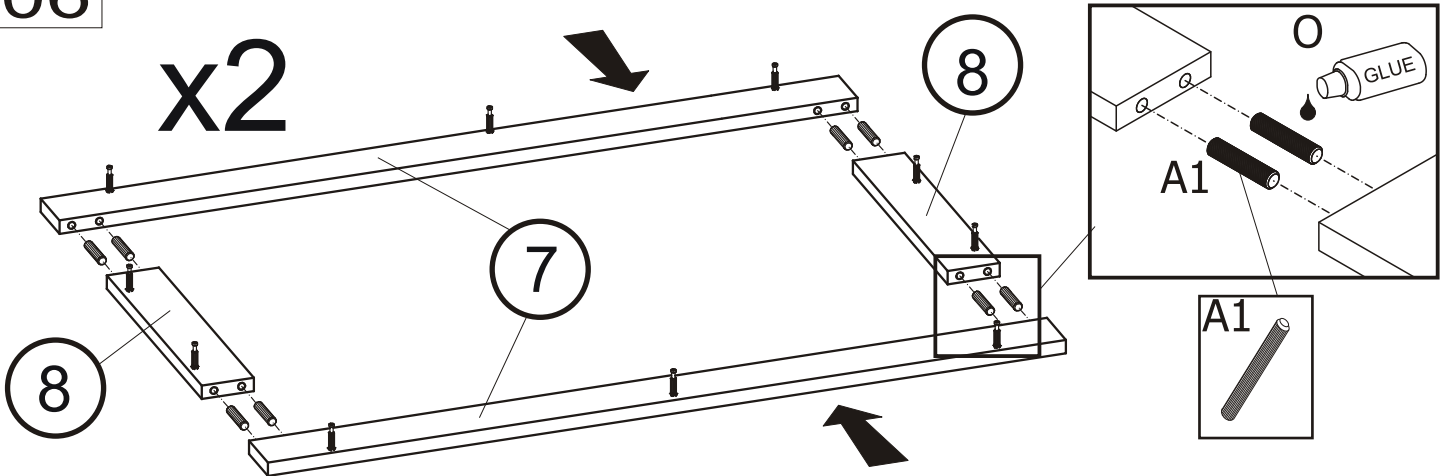

07

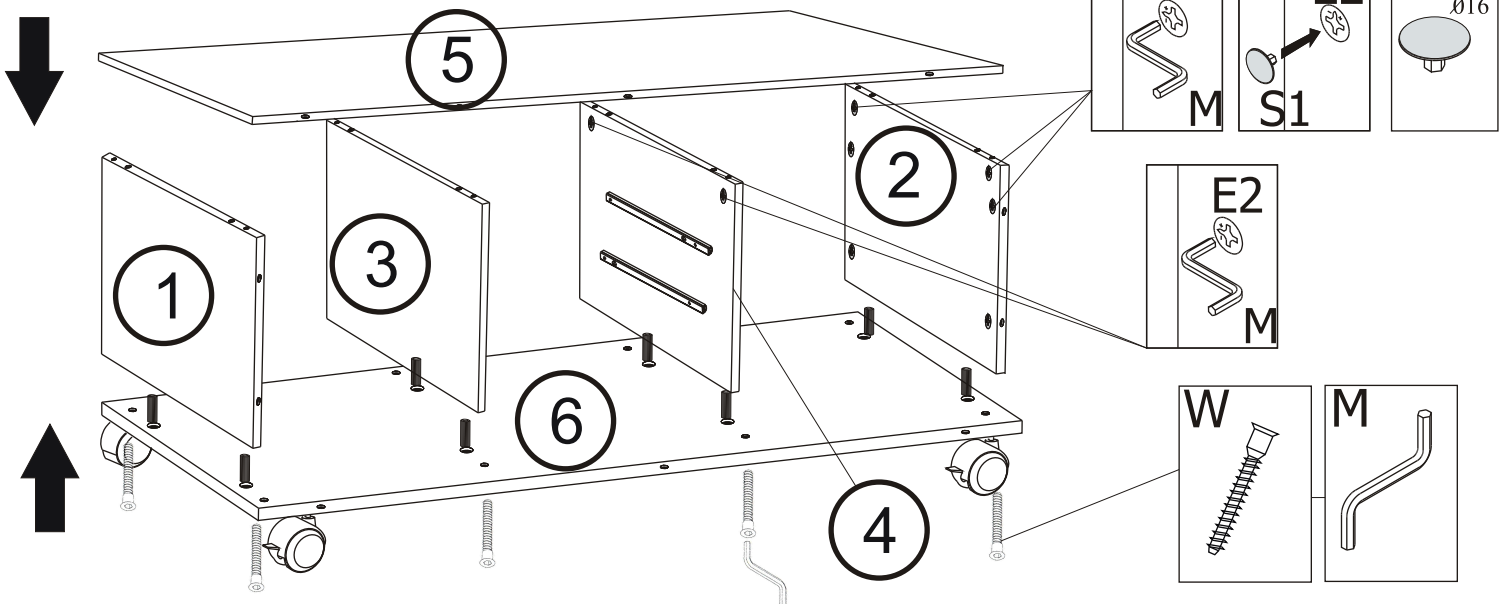

# STONE Couchtisch

Nr 4/6

08

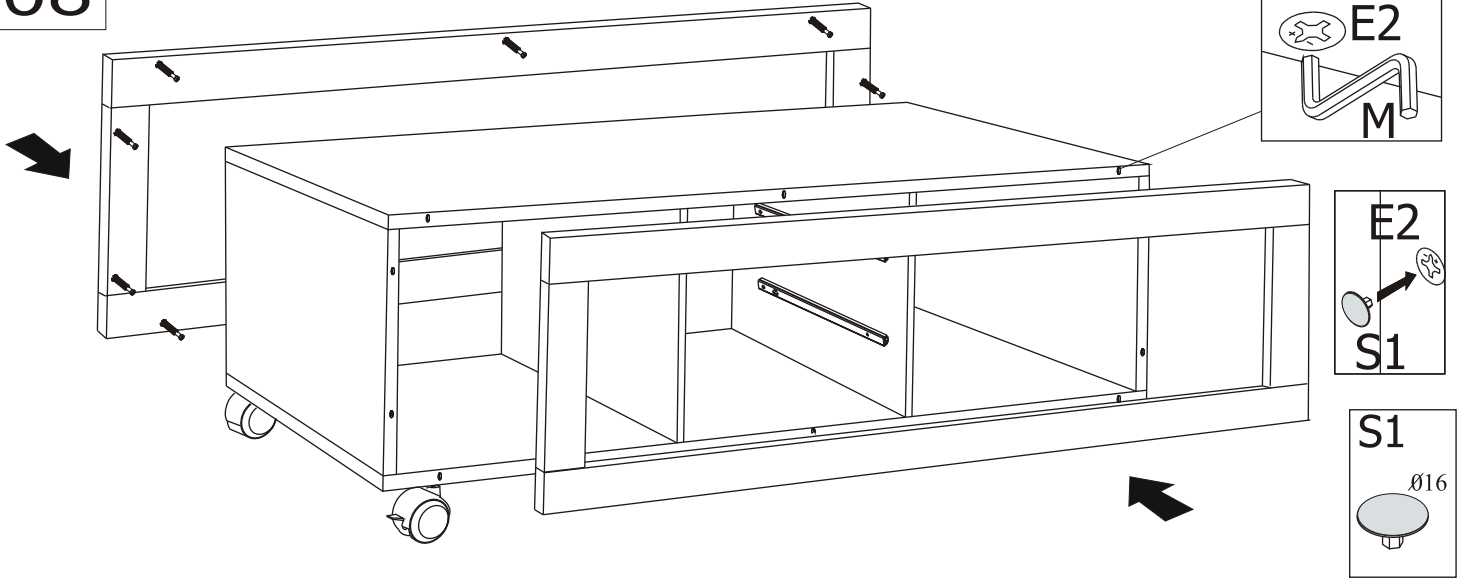

09

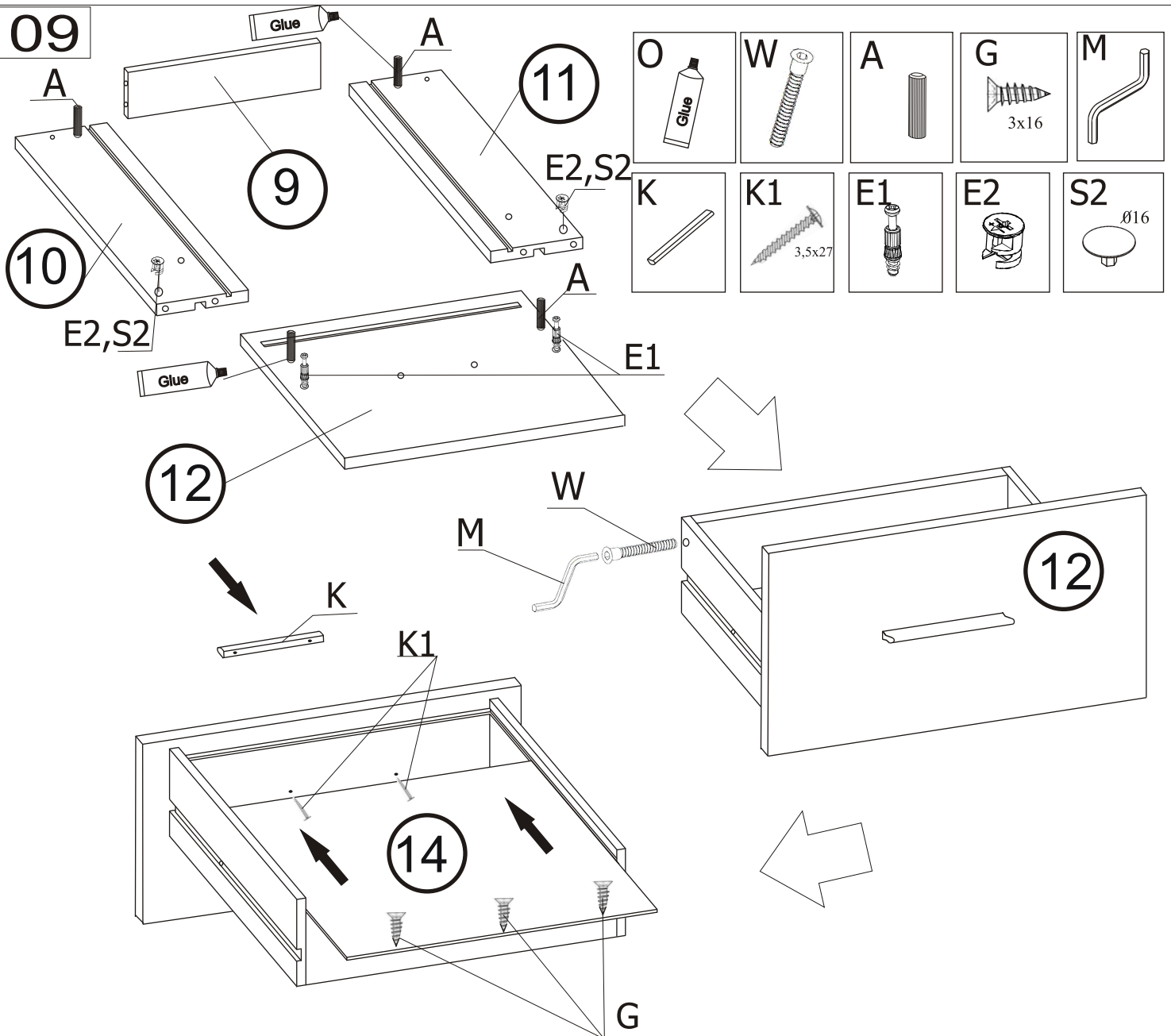

10

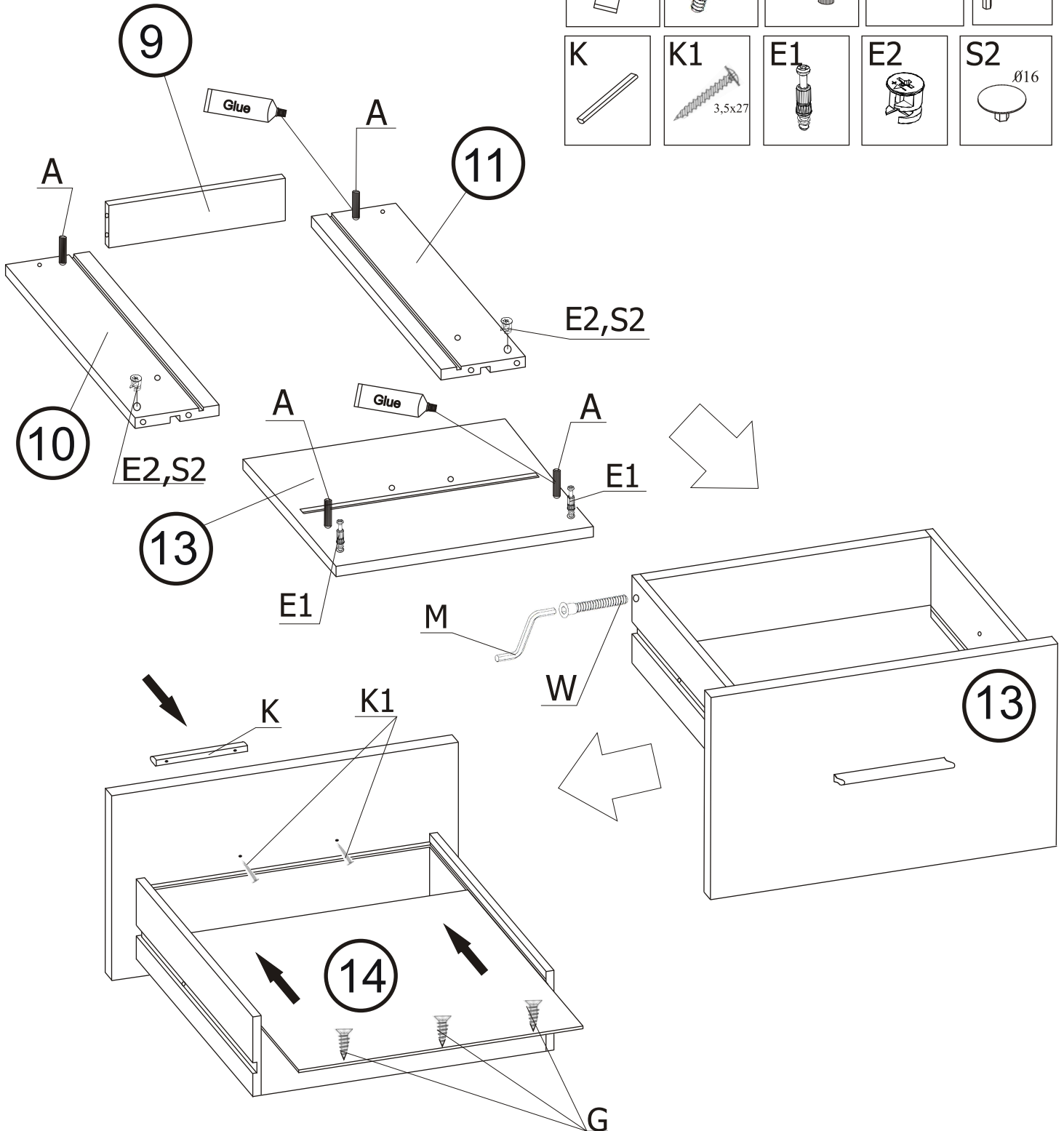
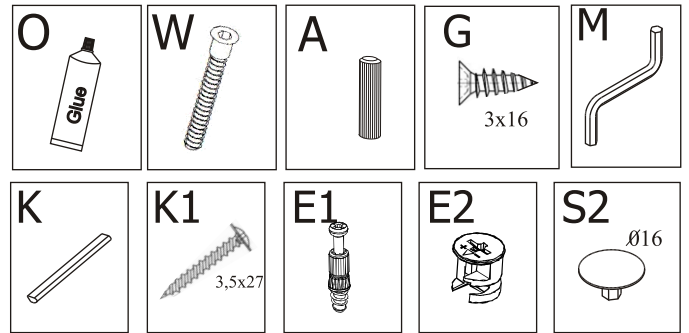

11

