

# Montageanleitung

Notice de montage

Assembly instruction

**GERMANIA®**  
the furniture factory

## Schiebetürregal 4037

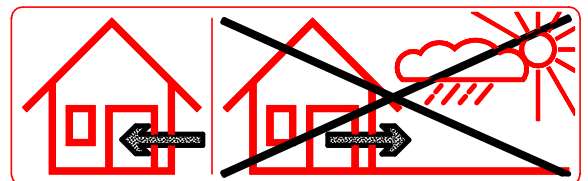
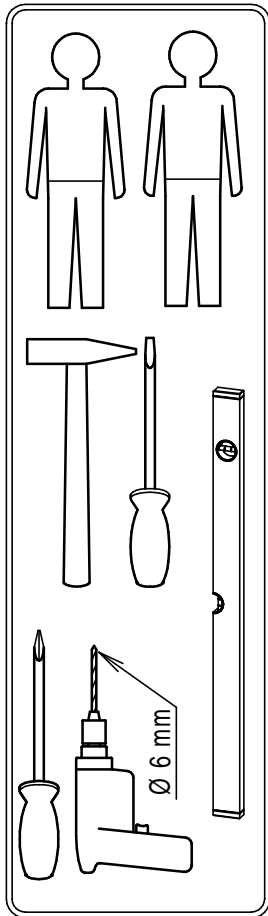
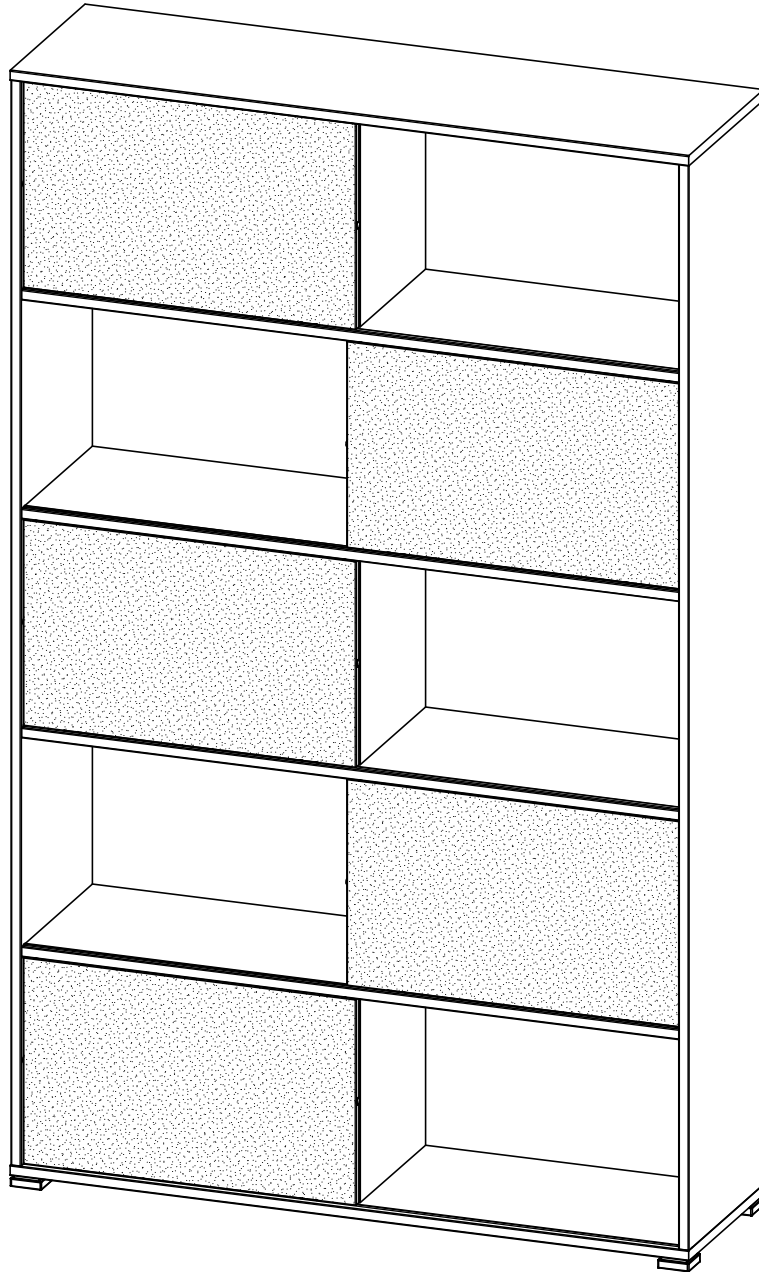









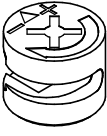

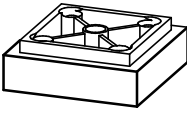

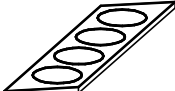
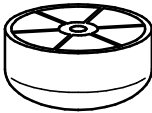

**Bitte die Sicherheitshinweise auf der letzten Seite beachten!**  
**Please note: safety instructions on the last page!**

**Prière de suivre les instructions de sécurité figurant sur la dernière page!**

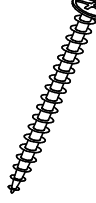
erstellt	geändert	geprüft
Datum: 25.04.2013	Datum:	Datum: 29.04.2013

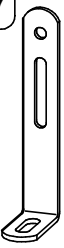
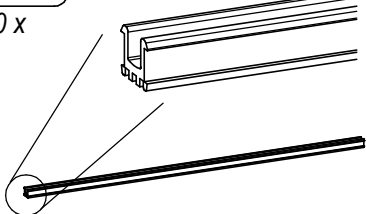
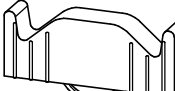
# Mod. 4037 **Teileliste** - liste de pièces - partlist

<p><b>2218</b> 44 x</p>  <p>Ø8 x 30mm</p>	<p><b>1116</b> 24 x</p>  <p>Ø15mm</p>	<p><b>1114</b> 24 x</p>  <p>24 mm</p>	<p><b>1162</b> 24 x</p> 	<p><b>5403</b> 4 x</p>  <p>55x55 mm</p>	<p><b>1071</b> 8 x</p>  <p>Ø4x30mm</p>
<p><b>4684</b> 3 x</p>  <p>Ø12x1,6 mm</p>	<p><b>4014</b> 5 x</p>  <p>Ø45 mm</p>	<p><b>1165</b> 5 x</p>  <p>Ø4x22mm</p>	<p><b>1267</b> 40 x</p>  <p>Ø3x16</p>	<p><b>4095</b> 4 x</p>  <p>10x10x13mm</p>	<p><b>1058</b> 4 x</p>  <p>Ø3x15mm</p>
<p><b>1110</b> 1 x</p>  <p>Ø6x30mm</p>	<p><b>1021</b> 1 x</p>  <p>Ø4,5x40mm</p>	<p><b>1298</b> 2 x</p>  <p>Ø4x15mm</p>	<p><b>1187</b> 1 x</p>  <p>90x30x15</p>	<p><b>4081</b> 10 x</p>  <p>1162 mm</p>	
<p><b>4075</b> 10 x</p> 	<p><b>4077</b> 10 x</p> 				

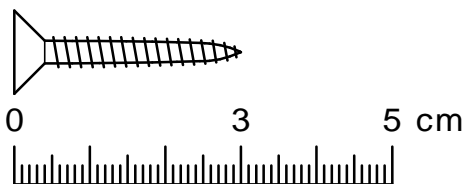

Mod. 4037 **Teileliste** - liste de pièces - partlist

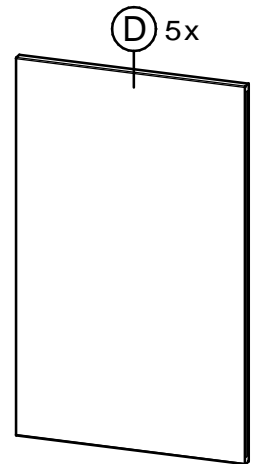
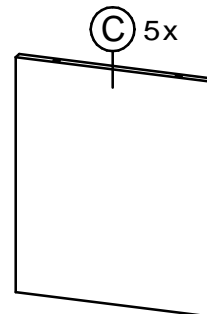
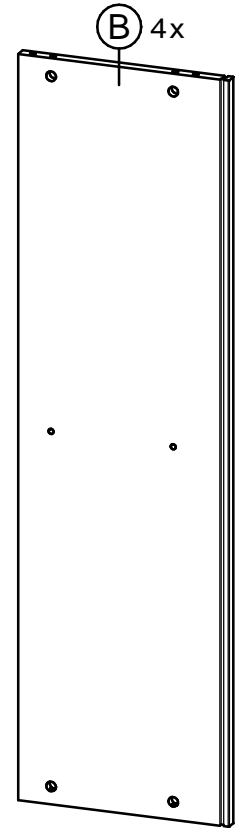
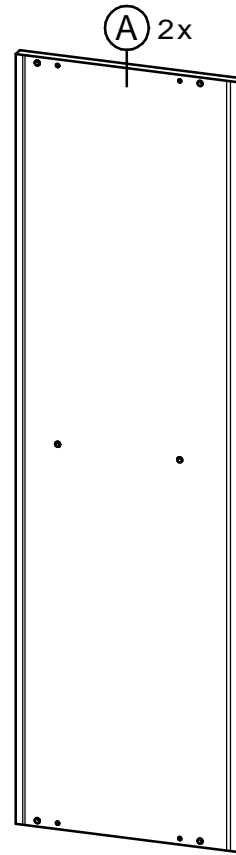
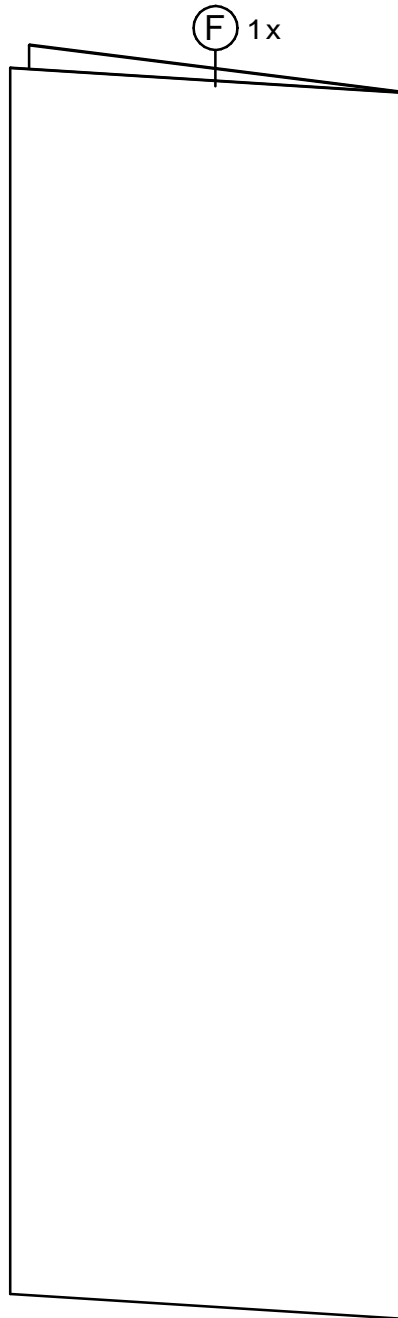
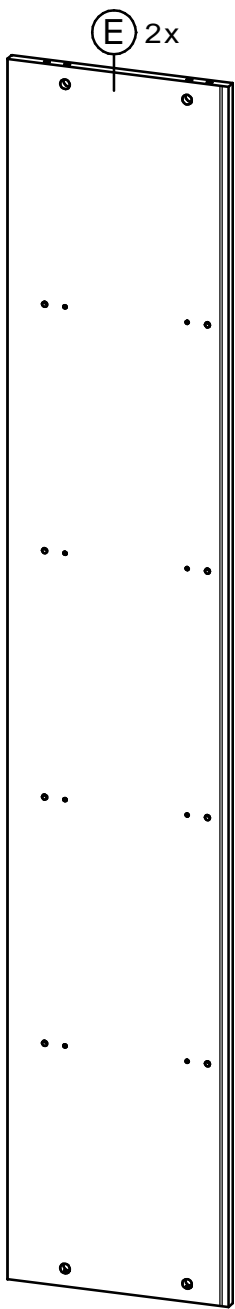

erstellt	geändert	geprüft
Datum: 25.04.2013	Datum:	Datum: 29.04.2013

# Mod. 4037 **Montageschritte** - ordre de montage - assembly instructions

**1.**

**1 x 1.1**

**1.2**

**1 x 1.3**

**4014** 5 x  $\varnothing 45$  mm

**1165** 5 x  $\varnothing 4 \times 22$  mm

**5403** 4x 55x55 mm

**1071** 8 x  $\varnothing 4 \times 30$  mm

**5465**

**1114** 2 x 1162 mm

**4081** 2 x 24 mm

**1114** 8 x 24 mm

**1114** 1 x

**4081**

**A**

**A**

**A**

**2.**

**4 x**

**2218** 16 x  $\varnothing 8 \times 30$  mm

**1116** 16 x  $\varnothing 15$  mm

**4081** 8 x 1162 mm

**2218**

**B**

**3.**

**2 x**

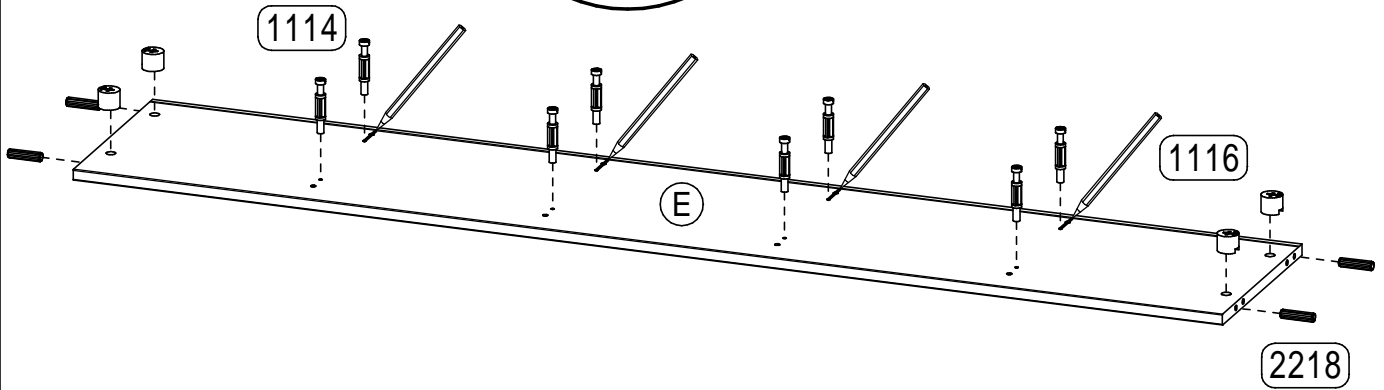
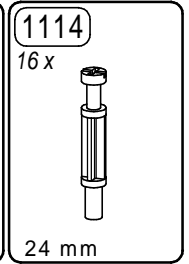
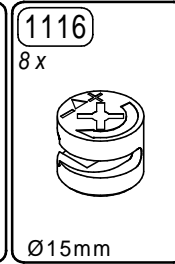
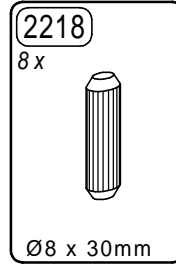
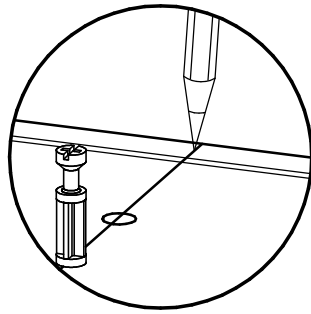

**4.**

**5 x**

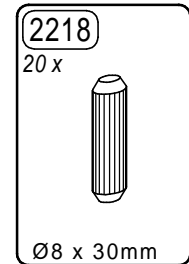
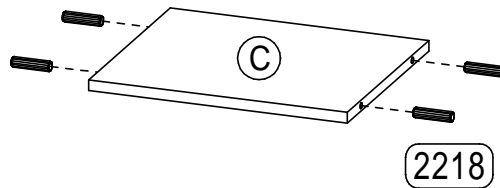

**5.**

**5 x**

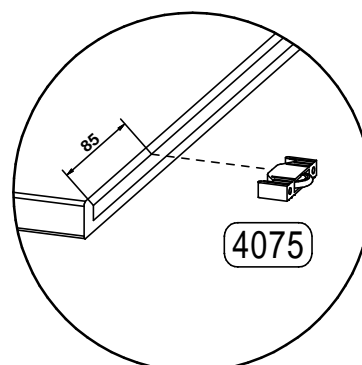
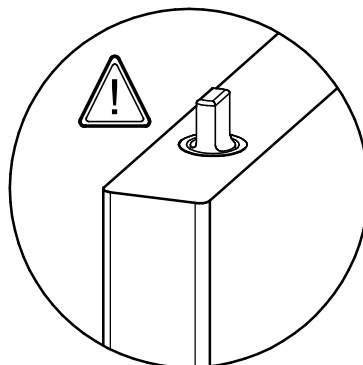
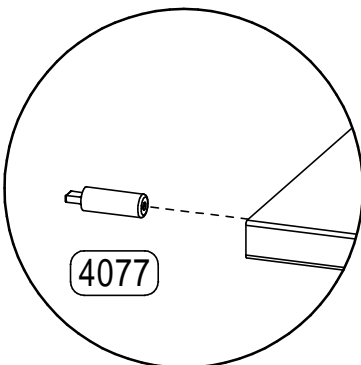
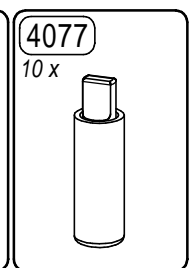
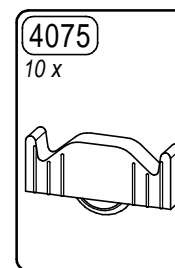
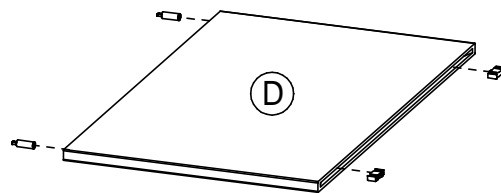

**6.**

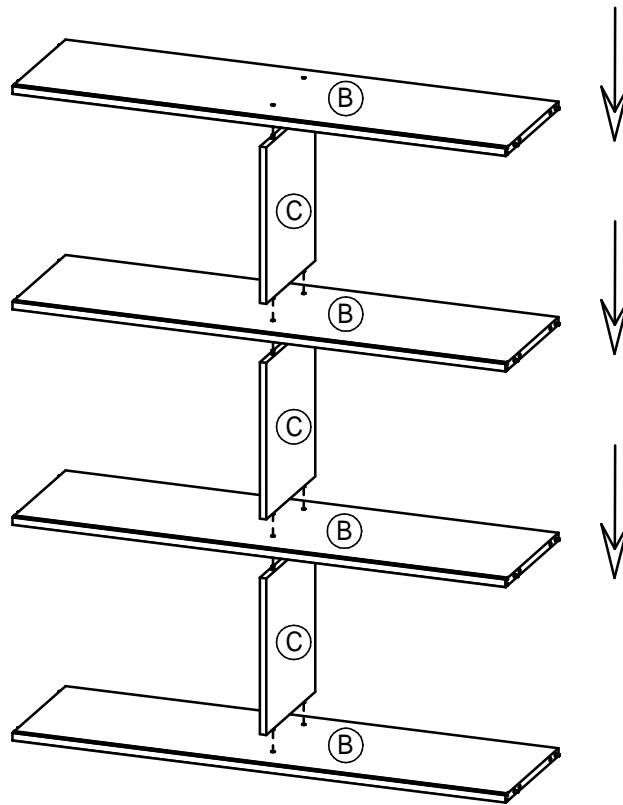
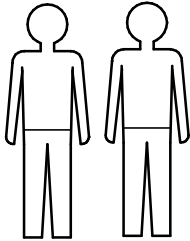

**7.**

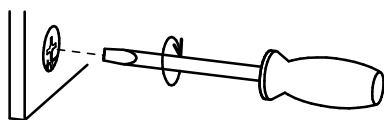
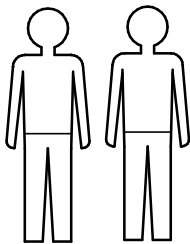

**7.2**

**7.1**

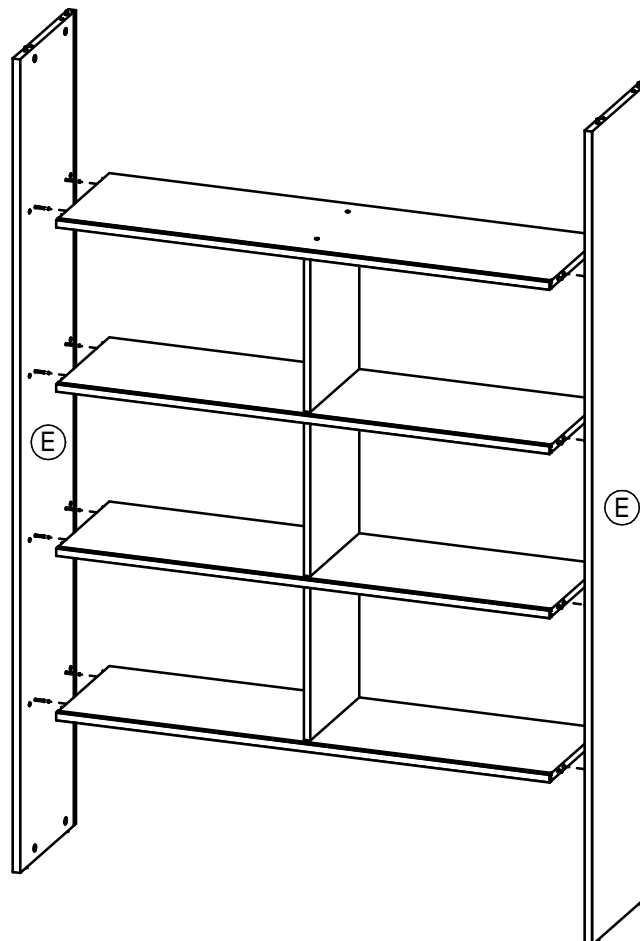

**7.1**



**6**

erstellt

Datum: 25.04.2013

geändert

Datum:

geprüft

Datum: 29.04.2013

**8.**

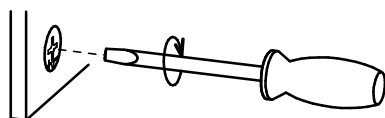
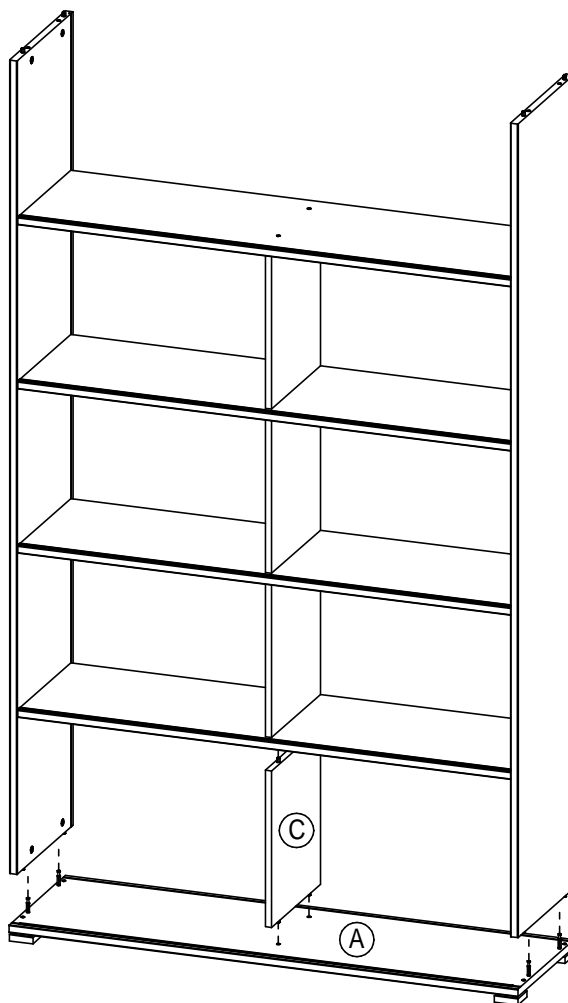
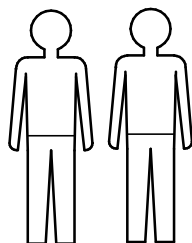

**8.2**

**9.**

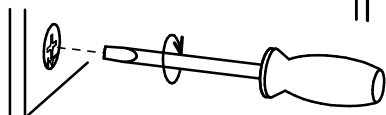
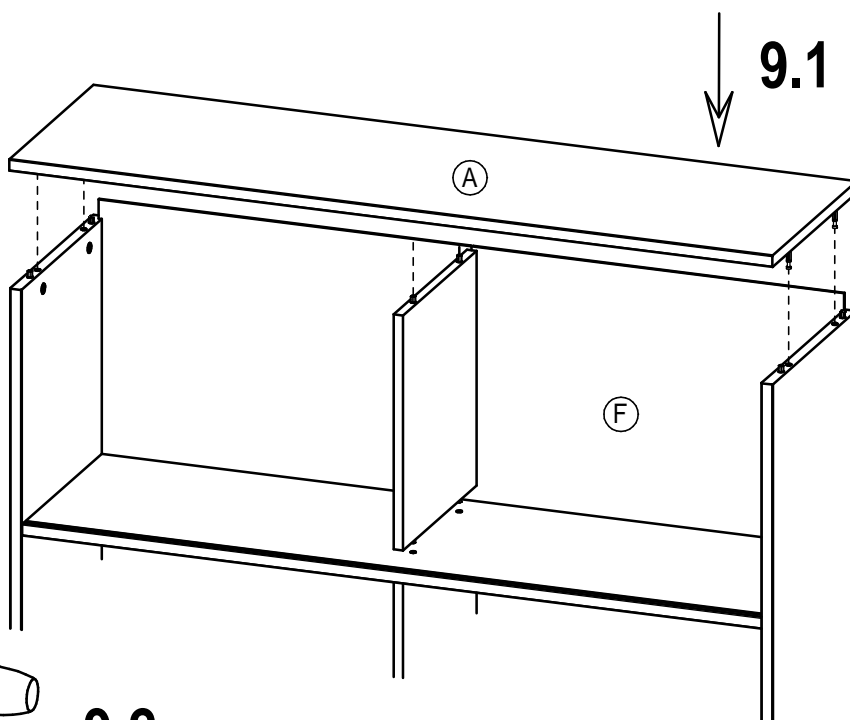

**9.2**

**7**

erstellt

Datum: 25.04.2013

geändert

Datum:

geprüft

Datum: 29.04.2013

**10.**

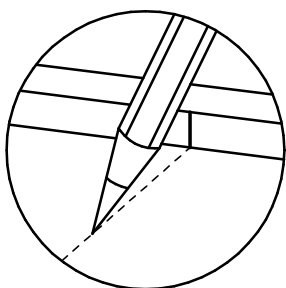
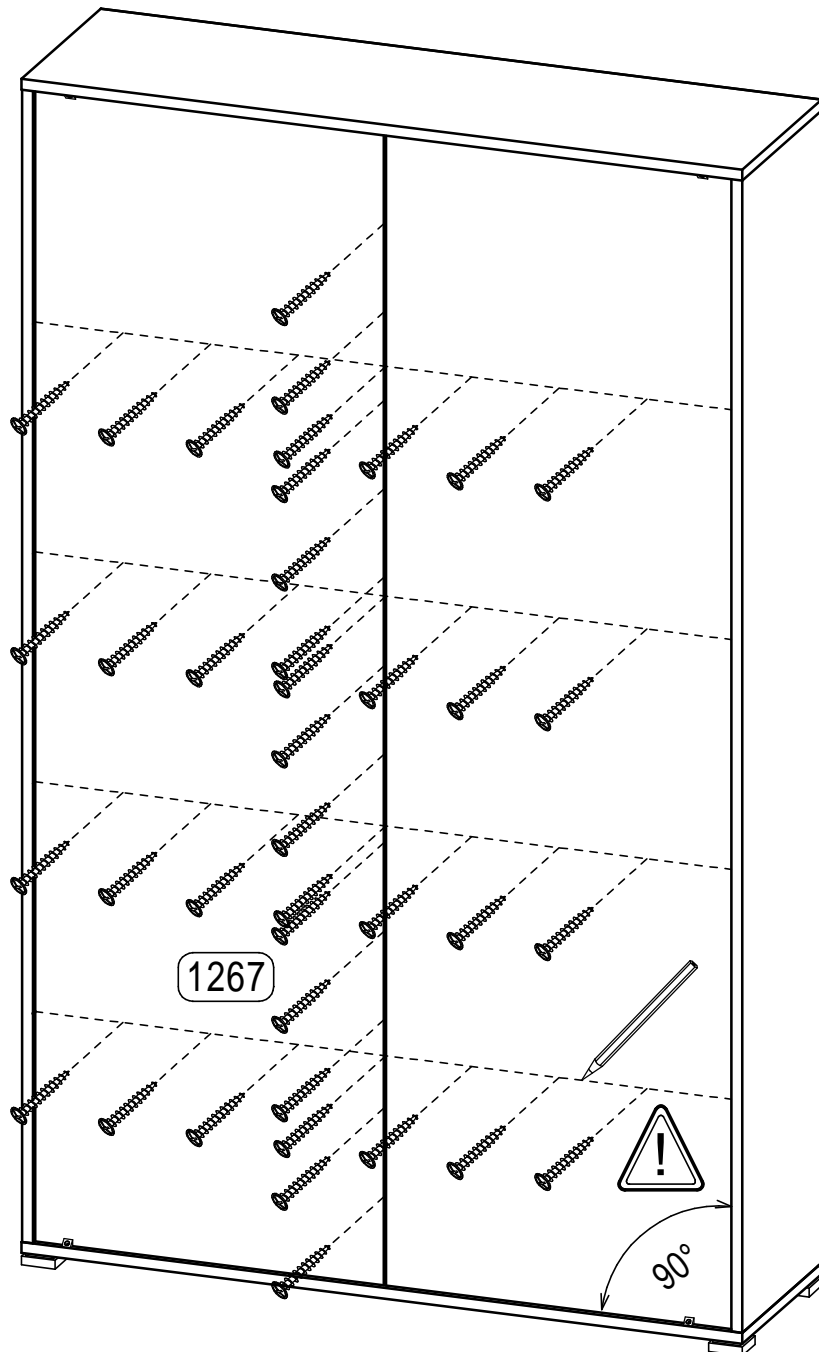
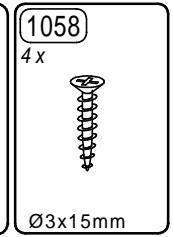
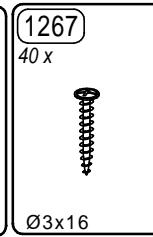
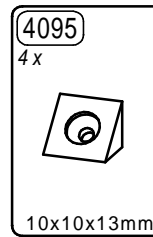
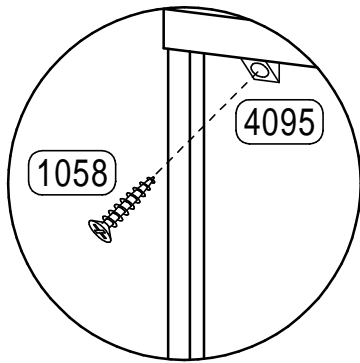

**8**

erstellt	geändert	geprüft
Datum: 25.04.2013	Datum:	Datum: 29.04.2013



**11.**

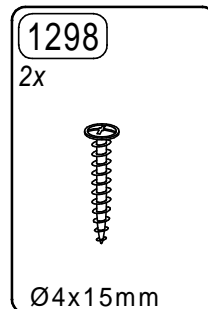
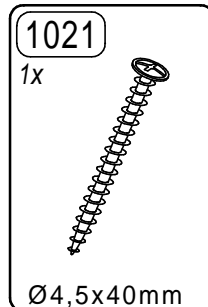
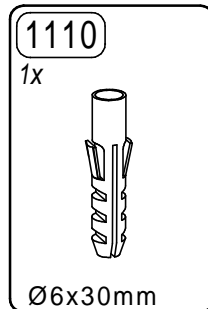
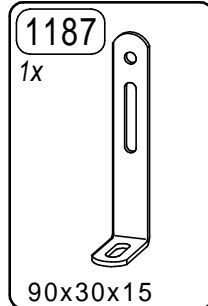
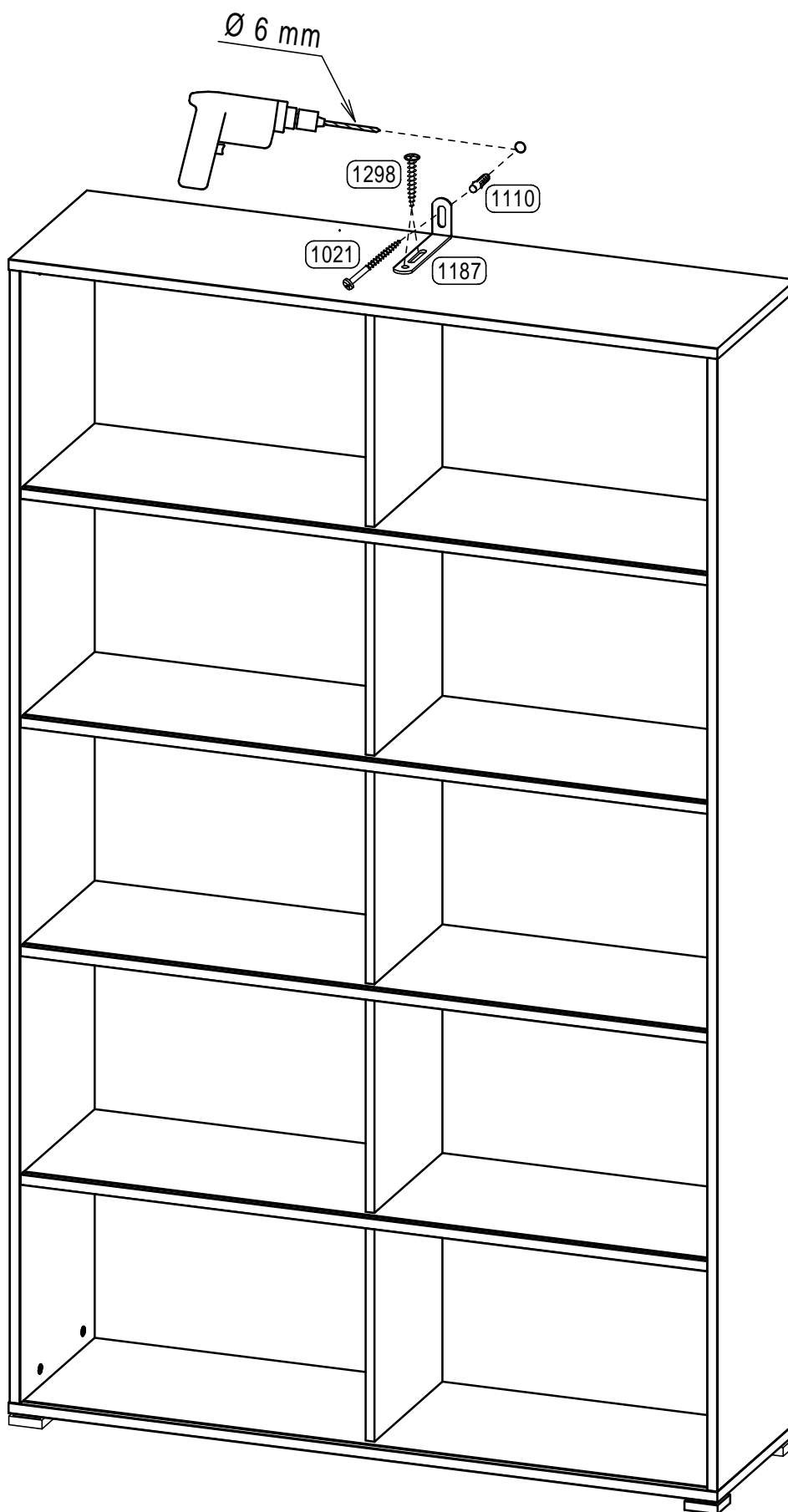

# 12.

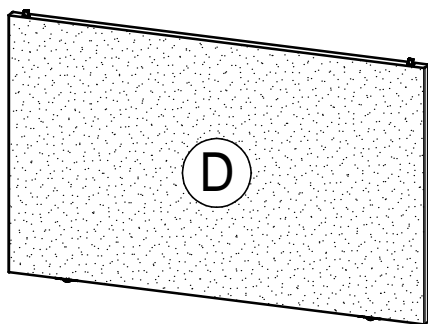
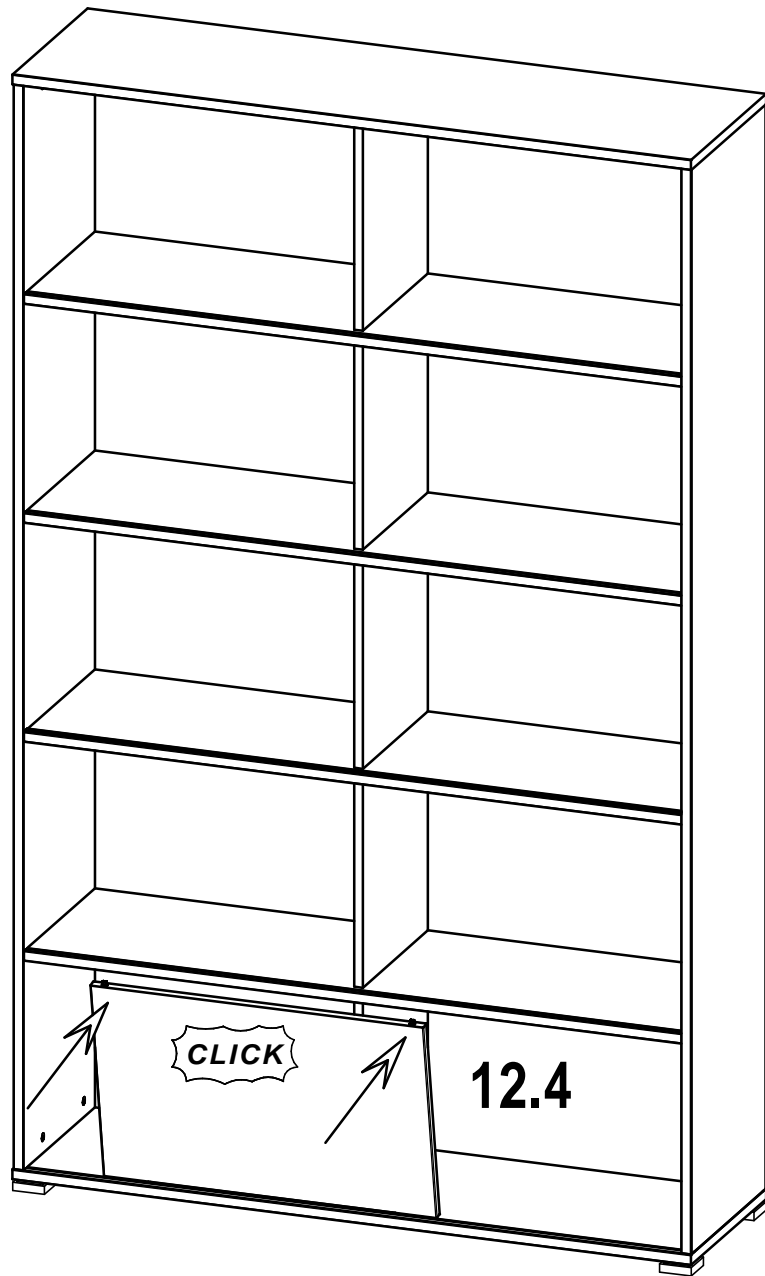
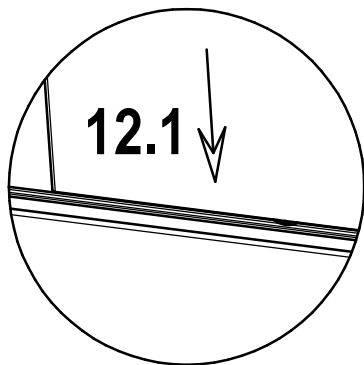
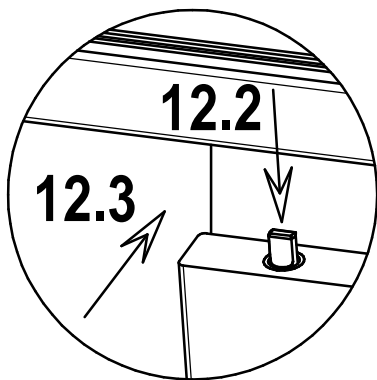

?

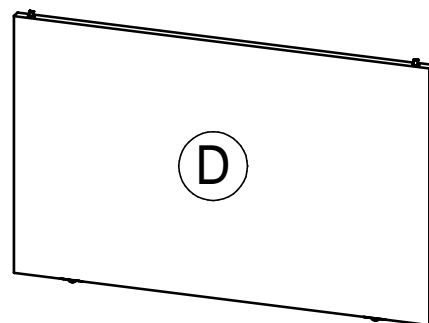

# 10

**13.**

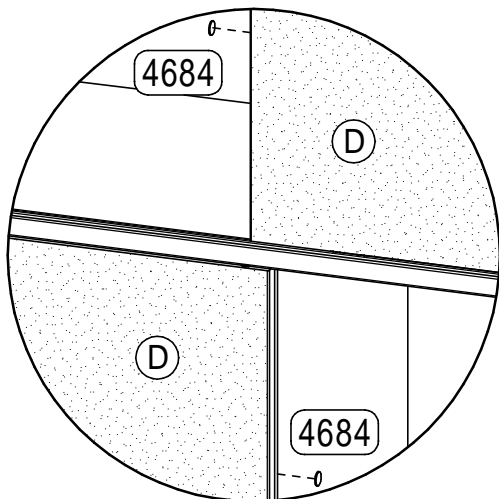
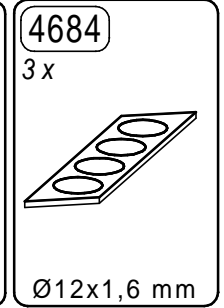
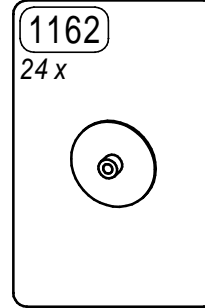
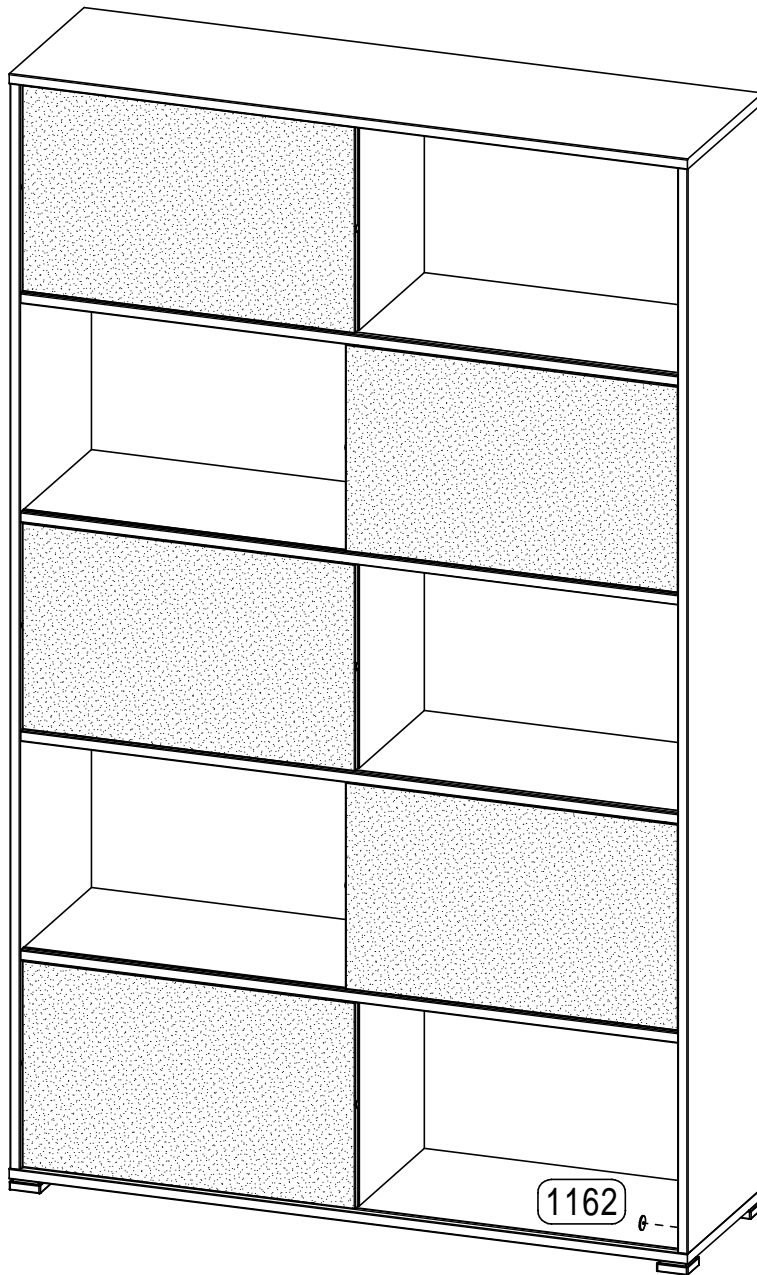

# Ersatzteil-Direkt Service

(nur für Deutschland - for germany only - seulement pour Allemagne)

Sehr geehrter Kunde,  
 Sollte ein Möbelteil bzw. Beschlagteil fehlen oder beschädigt sein, senden Sie uns den Artikel bitte **nicht** zurück, sondern fordern Sie der Einfachheit halber Ersatz direkt bei **GERMANIA** an.  
 Tragen Sie Ihren Bedarf in die Tabelle ein und übermitteln Sie uns diese Seite per Post, per Fax, telefonisch oder per e-mail.

Bitte unbedingt die MODELL-Nr. + DEKOR-Nr. (siehe Karton) und die entsprechende Teilebezeichnung (siehe Teileliste) angeben.

Mod. Nr.: \_\_\_\_\_ Dekor-Nr.: \_\_\_\_\_



Serie  
1234



Beispiel

Möbelteile			
Teil	beschäd.	fehlt	Anzahl
Z	X		1

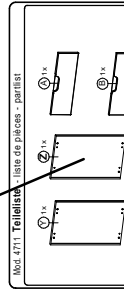

Beispiel

Beschlagteile			
Teil	beschäd.	fehlt	Anzahl
1162		X	2

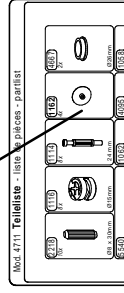

**Absender nicht vergessen :**

Name: \_\_\_\_\_ Strasse u. Nr.: \_\_\_\_\_  
 PLZ: \_\_\_\_\_ Ort : \_\_\_\_\_  
 Tel.: \_\_\_\_\_ Fax: \_\_\_\_\_ e-mail: \_\_\_\_\_

**Unsere Hotline :**

Tel. 05252 84939 und 05252 84962 Fax: 05252 84936  
 e-mail : service@mygermania.com

**GERMANIA** - Service - Postfach 1160 D 33189 Schlangen

# Sicherheitshinweise

## Safety instructions

## Indications de sécurité

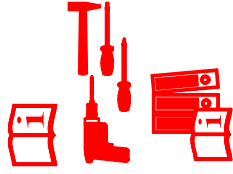

- 1.) Montageanleitung aufmerksam durchlesen  
 Please read assembly instruction carefully  
 Prière de bien lire la notice de montage du début à la fin
- 2.) Montage nach Montageanleitung durchführen  
 Please follow the assembly instruction step by step  
 Bien suivre le sens du montage indiqué sur la notice
- 3.) Montageanleitung aufbewahren  
 Please save the assembly instruction  
 Bien conserver la notice de montage



**ACHTUNG!** Beschlagteile und Beschlagteile von Säuglingen und Kindern fernhalten  
**ATTENTION!** To avoid suffocation keep plastic bag away from children  
 Certains small parts which may be a choking hazard  
**ATTENTION!** Toutes les pièces détachées livrées dans le colis être mis hors de portée des bébés des et enfants

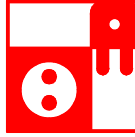

Netzanschluss (230V) nur von einem Fachmann ausführen lassen.  
 Sanitäranschluss nur von einem Fachmann ausführen lassen.  
 Mains connection (230V) has to be done by an expert.  
 Sanitary installation has to be done by an expert.  
 L'électricité (230V) uniquement à faire par un électricien.  
 Installation sanitaire à faire par un spécialiste.



Beiliegendes Befestigungsmaterial eignet sich nur für Massivwände.  
 Für andere Wände müssen Spezialdübel verwendet werden.  
 Die Festigkeit ist zu Prüfen.

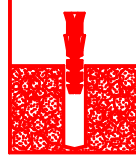

The attached fixing materials is only suitable for solid walls.  
 For other Types of walls special dowels have to be used.  
 The firmness have to be checked.

Le matériel de fixation ci-joint est exclusivement prévu pour des murs pleins( une fixation spéciale est nécessaire pour cloisons placo,...).  
 La fermete est a examiner.

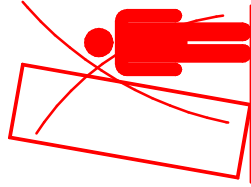

Beiliegende Wandbefestigungen dienen als Kippschutz, unbedingt anbringen!

The attached wall fixing is necessary to avoid tipping and must be fixed!

Les fixations prévues dans le colis préviennent contre le renversement du meuble. Il faut impérativement fixer le meuble au mur, afin d'éviter tout incident!

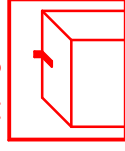

Für Schäden, die durch unsachgemäße Montage entstanden sind, übernehmen wir keine Haftung.  
 For the damages, which have originated from improper assembly, we take over no liability.  
 Pour les dommages qui sont nés par le montage incorrect, nous ne prenons en charge aucune responsabilité.