

**D****Wichtige Pflegehinweise**

Bitte beachten Sie die wichtigen Pflegehinweise auf unserer Internetseite

[www.till-hilft.de](http://www.till-hilft.de)

Pflegehinweise

**PL****Ważne instrukcje dotyczące pielęgnacji**

Zwróć uwagę na ważną instrukcję dotyczącą pielęgnacji na naszej stronie internetowej

[www.till-hilft.de](http://www.till-hilft.de)

Pflegehinweise

**GB****Important care instructions**

Please note the important care instructions on our website

[www.till-hilft.de](http://www.till-hilft.de)

Pflegehinweise

**SK****Dôležité pokyny na starostlivosť**

Dbajte na dôležité pokyny týkajúce sa starostlivosti na našich webových stránkach

[www.till-hilft.de](http://www.till-hilft.de)

Pflegehinweise

**FR****Instructions d'entretien importantes**

S'il vous plaît noter les instructions de soins importants sur notre site Web

[www.till-hilft.de](http://www.till-hilft.de)

Pflegehinweise

**HU****Fontos kezelési utasítások**

Kérjük, vegye figyelembe a honlapunkon található fontos kezelési útmutatót

[www.till-hilft.de](http://www.till-hilft.de)

Pflegehinweise

**IT****Importanti istruzioni per la cura**

Si prega di notare le importanti istruzioni per la cura sul nostro sito web

[www.till-hilft.de](http://www.till-hilft.de)

Pflegehinweise

**RO****Instrucțiunile importante de îngrijire**

Rețineți instrucțiunile importante de îngrijire de pe site-ul nostru

[www.till-hilft.de](http://www.till-hilft.de)

Pflegehinweise

**NL****Belangrijke zorginstructies**

Let op de belangrijke zorginstructies op onze website

[www.till-hilft.de](http://www.till-hilft.de)

Pflegehinweise

**TR****Önemli bakım talimatları**

Lütfen web sitemizdeki önemli bakım talimatlarını dikkate alınız

[www.till-hilft.de](http://www.till-hilft.de)

Pflegehinweise

**CZ****Důležité pokyny pro péči**

Vezměte prosím na vědomí důležité pokyny pro péči na našich webových stránkách

[www.till-hilft.de](http://www.till-hilft.de)

Pflegehinweise

**RU****Важные инструкции по уходу**

Обратите внимание на важные инструкции по уходу на нашем веб-сайте

[www.till-hilft.de](http://www.till-hilft.de)

Pflegehinweise





88143.535

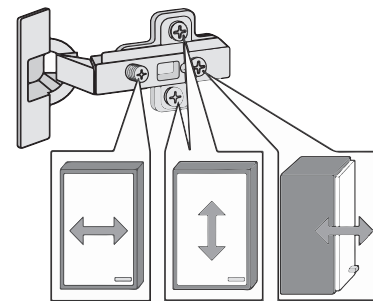
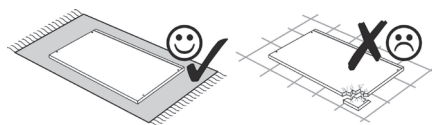
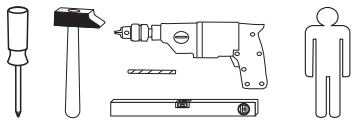

1 4 x 2802	2 4 x 2801	gedämpft 3 2 x 1504	ungedämpft 4 2 x 1505	5 4 x 1613
6 8 x 30 8 x 30 2861	7 2 x 5674	8 2 x 2865	9 2 x	11 5,8 x 55 2 x 2840
12 8 x 30 2 x 2842	13 2 x 2843	14 4 x 30 4 x 2812	15 3,5 x 15 10 x 2804	16 Leim 2 x 2863
17 25 x 2862	18 35 mm 4 x 2886			

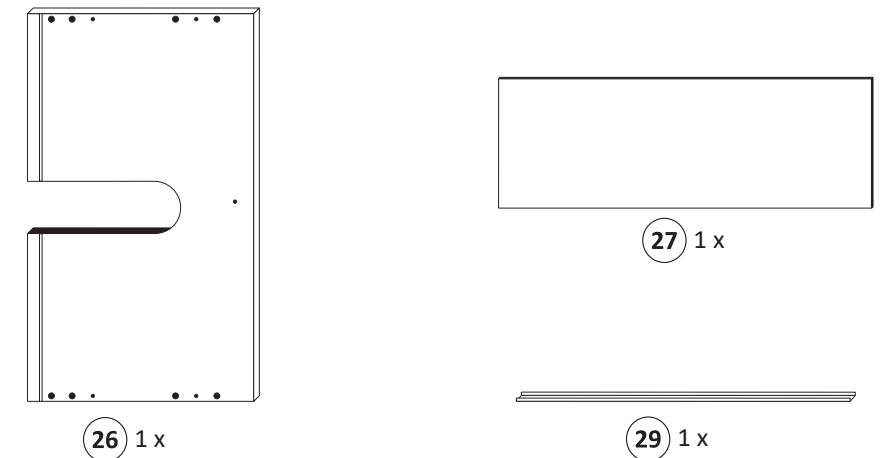
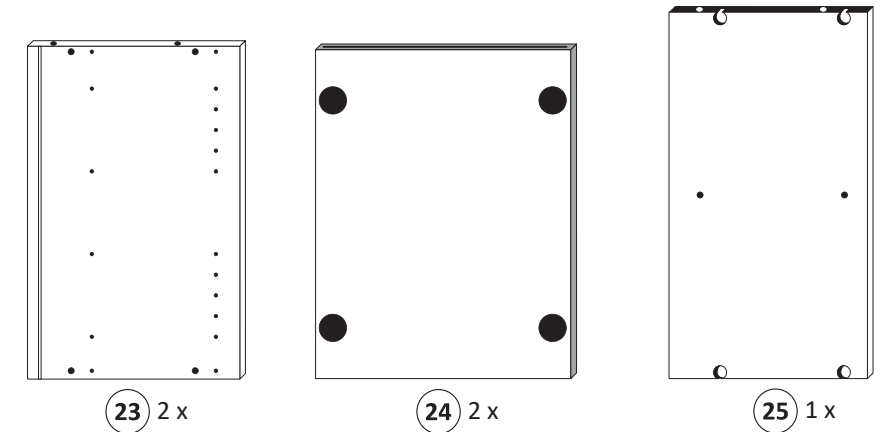
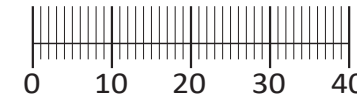

Das beigefügte Wandbefestigungsmaterial (Dübel und Schrauben) eignet sich nur für festes Mauerwerk (z.B.: Beton- oder Ziegelwände). Für andere Wandaufbauten sind eventuell Spezialdübel und andere Schrauben notwendig. Ziehen Sie gegebenenfalls eine Fachkraft zu Rate.

De begeleidende wandmontage hardware (pluggen en schroeven) is alleen geschikt voor massief metselwerk (bijvoorbeeld beton of bakstenen muren). Voor andere muur structuren zijn eventueel bijzondere ankerbouten en andere noodzakelijke. Draai indien nodig, een deskundige.

Приложенный материал для крепления к стене (дюбели и винты) пригоден только для жестких кладок (например, бетонные или кирпичные стены). Для других настенных конструкций необходимы смотря по обстоятельствам специальные дюбели и другие винты. При необходимости проконсультируйтесь у специалиста.

Le mur d'accompagnement matériel de montage (chevilles et les vis) ne convient que pour la maçonnerie solide (par exemple en béton ou des murs de briques). Pour les structures de mur d'autres sont peut-être spéciale boulons d'ancrage et d'autres nécessaires. Serrer le cas échéant, un expert.

Zalączony materiał do mocowania do ściany (kolki rozprężne i wkręty) nadaje się tylko do ścian murowanych (np. z betonu lub cegieł). Do ścian wykonanych w innych technologiach konieczne być mogą specjalne kolki rozprężne i inne wkręty. W razie potrzeby skorzystaj z fachowej pomocy

Il muro di accompagnamento hardware di montaggio (tasselli e viti) è'e adatto solo per muratura piena (ad esempio calcestruzzo o muratura). Per le altre strutture murarie sono forse speciali bulloni di ancoraggio e necessari di altri. Serrare se necessario, un esperto.

The accompanying wall mounting hardware (anchors and screws) is suitable only for solid masonry (eg concrete or brick walls). For other wall structures are possibly special anchor bolts and other necessary. Tighten if necessary, an expert.

Ekteki duvara sabit montaj malzemeleri (dübel ve vidalar), sadece sağlam duvarlar için (örnek: beton veya tuğla) elverişlidir. Başka duvarlar için özel dübeller ve farklı vidalar gerekebilir. Gerektiğinde bir uzmana danışınız.

1

1 4 x 2802	5 4 x 1613	6 8 x 30 8 x 30 2861	13 2 x 2843	14 4 x 30 4 x 2812	16 Leim 1 x 2863
------------------	------------------	-------------------------------	-------------------	-----------------------------	---------------------------

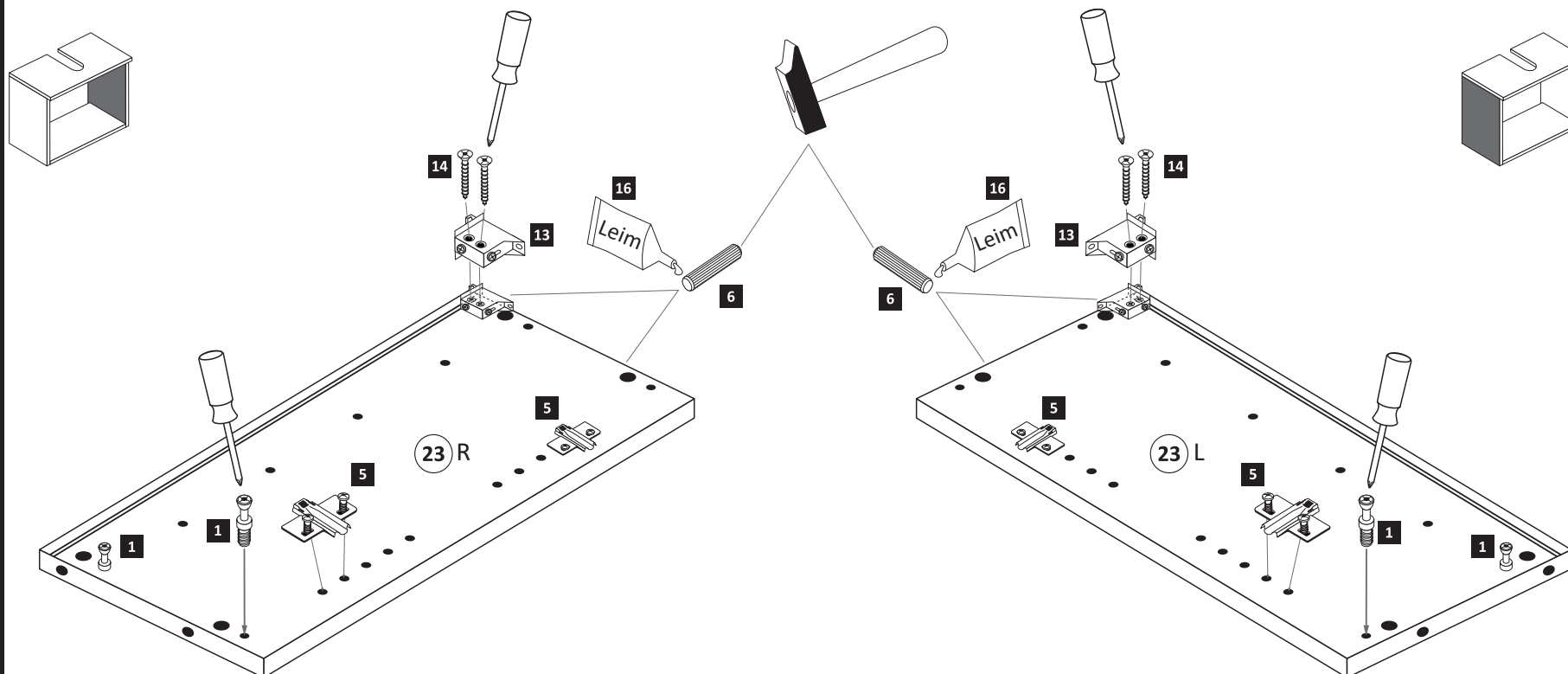

2

2 4 x 2801	6 8 x 30 8 x 30 2861	9 8mm 2 x	16 Leim 1 x 2863
------------------	-------------------------------	-----------------	---------------------------

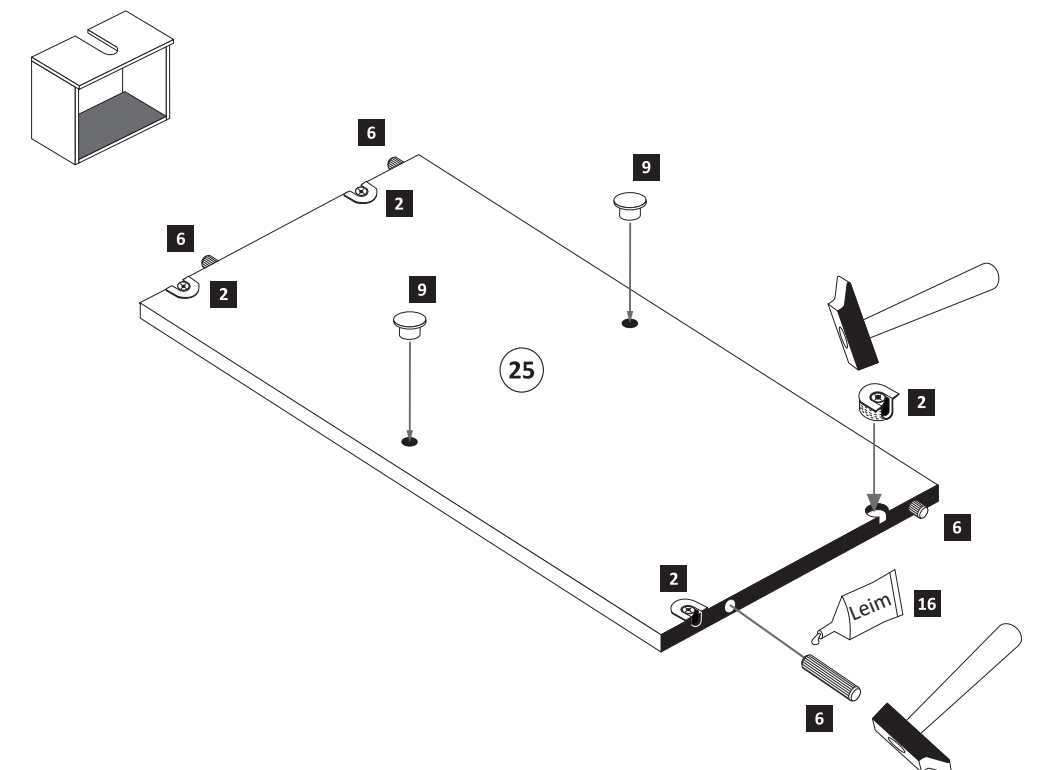

**3**

3,5 x 15	2 x	1 x
15	2804	2863

Leim

20 min.

D Leim  
GB Glue  
NL Lijm  
PL Klej  
TR Tutkal  
F Colle  
I Colla

**4**

25 x	1 x
2862	2862

**5**

gedämpft	ungedämpft	3,5 x 15	35 mm
3	4	8 x	4 x
1504	1505	2804	2886

**6**

2 x	1 x
5674	2863

Leim

**7**

Scharniermontage

Scharnier lösen 2.

**8**

5,8 x 55	8 x 30
2 x	2 x
2840	2842



1 4551

