

MONTAGEANLEITUNG / SERVICEKARTE

MONTAGEANLEITUNG SOLLTE NICHT ALS TECHNISCHE DOKUMENTATION BETRACHTET WERDEN. AUFBAUANDEUTUNGEN VOM PRODUZENTEN VORBEHALTEN

SEHR GEEHTER KUNDE, SOLLTE EIN TEIL FAHLEN ODER BESCHADIGT SEIN, KREUZEN SIE BITTE DIESES DEUTLICH AUF DER SERVICEKARD AN UND SCHICKEN SIE UNS DIE SERVICEKARD ZURÜCK.

DEN KLEBER BENUTZEN SIE NUR ZUM VERLEIMEN DER SCHUBLADEN.

UM DIE EVENTUELLEN REKLAS RICHTUNG ZU ERLEDIGEN, BITTEN WIR UM EINE KOPIE DES AUFKLEBERS VON DER WARE, ODER UM ANGABE DER PRODUKTIONSWOCHE.

TEILNUMMER	TEILNAHR	MASS	STÜK
①	864x350x16	1	2/2
②	864x350x16	1	2/2
③	1137x350x16	1	1/2
④	1170x353x16	1	1/2
⑤	760x60x16	1	1/2
⑥	760x60x16	1	1/2
⑦	1171x60x16	1	1/2
⑧	1171x60x16	1	1/2
⑨	200x350x16	1	1/2
⑩	200x350x16	1	1/2
⑪	200x350x16	1	1/2
⑫	150x346x16	3	2/2
⑬	310x110x16	3	1/2
⑭	310x110x16	3	1/2
⑮	293x84x16	3	2/2
⑯	335x318x3	3	1/2
⑰	600x346x16	1	2/2
⑱	600x346x16	1	2/2
⑲	600x346x16	1	2/2
⑳	826x404x3	2	1/2
㉑	804x350x16	1	2/2
㉒	826x354x3	1	1/2
㉓	385x350x16	1	1/2
㉔	735x350x16	1	1/2

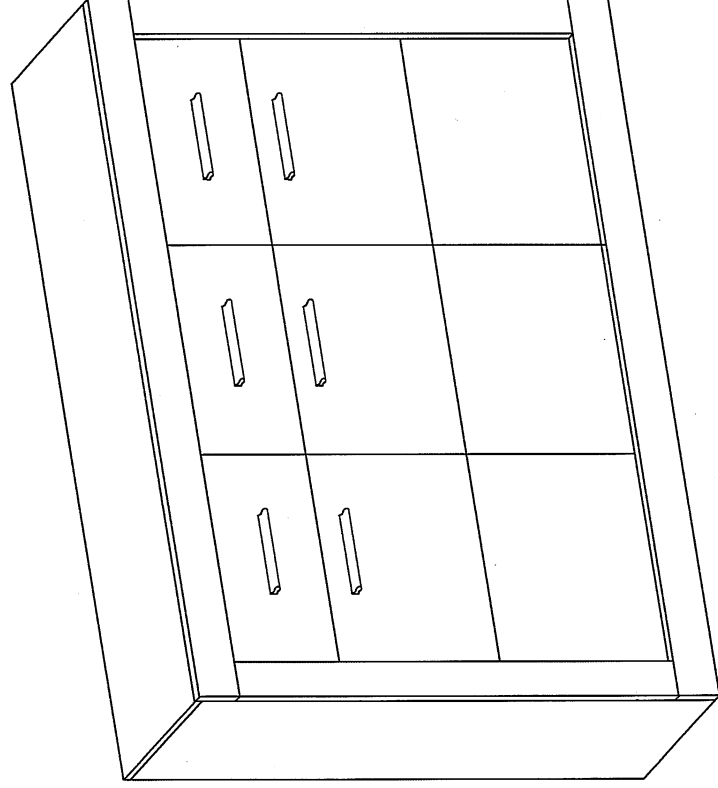

D	x4	H1	x4	H	x2	J	4x13 x12	S1	Ø16 x36	S	x36	B	x36	W	x6	W1	Ø11 x6	M	x1	A	x30	A1	x8
D1	x2	O	x1	C	x3	E	mini euro screw 4x13 x12	K	x6	P	M4x12 x6	K1	3.5x27 x12	G	x8	F	x4	U	x60	N	x7		

CAN CAN Kommode 2

Nr 2/8

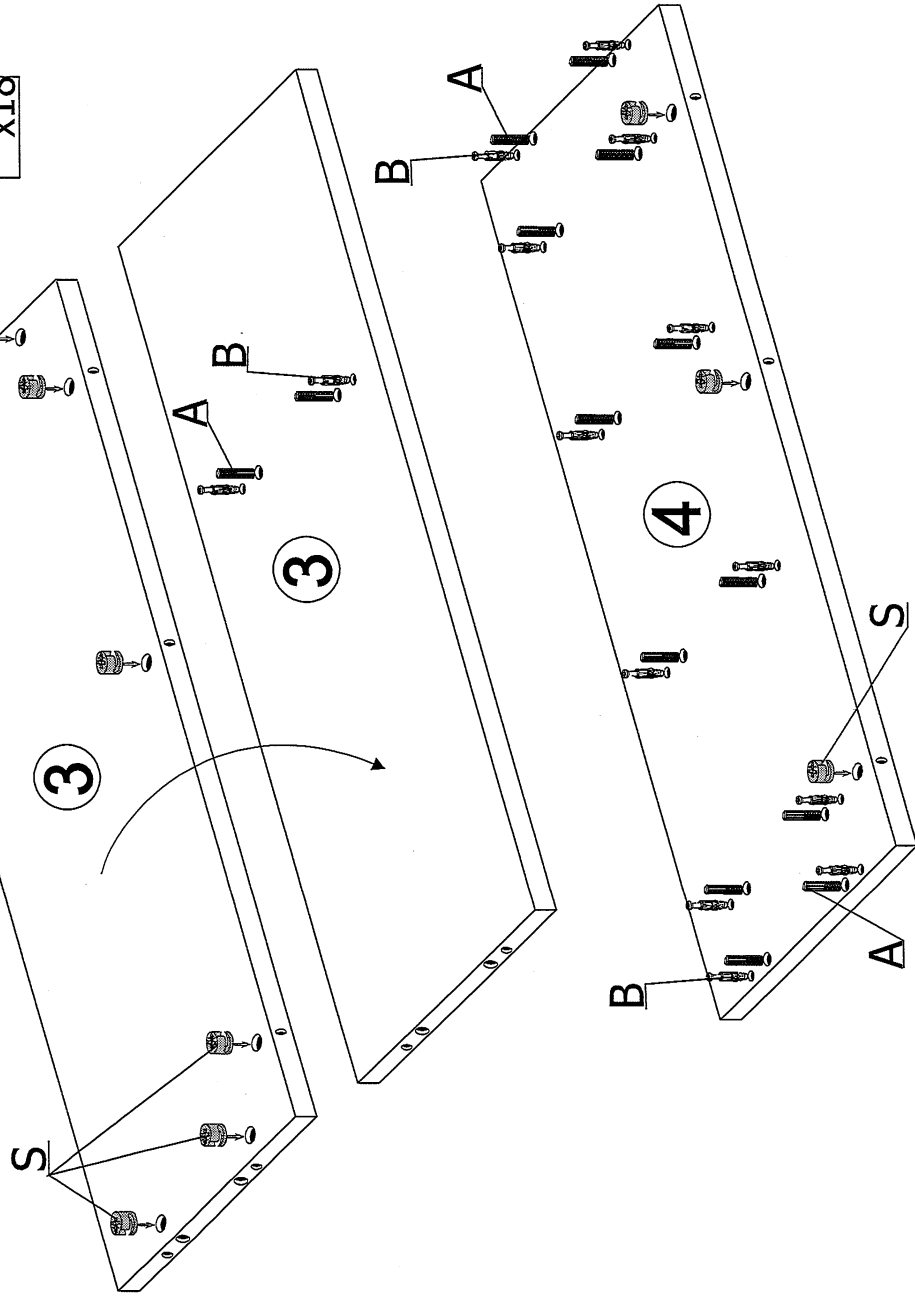
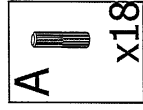
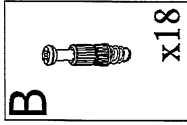
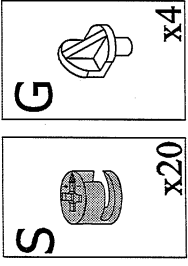
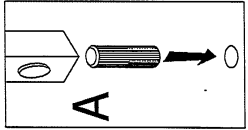
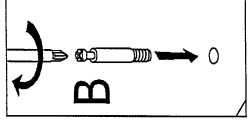
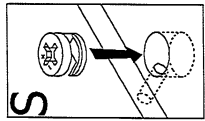
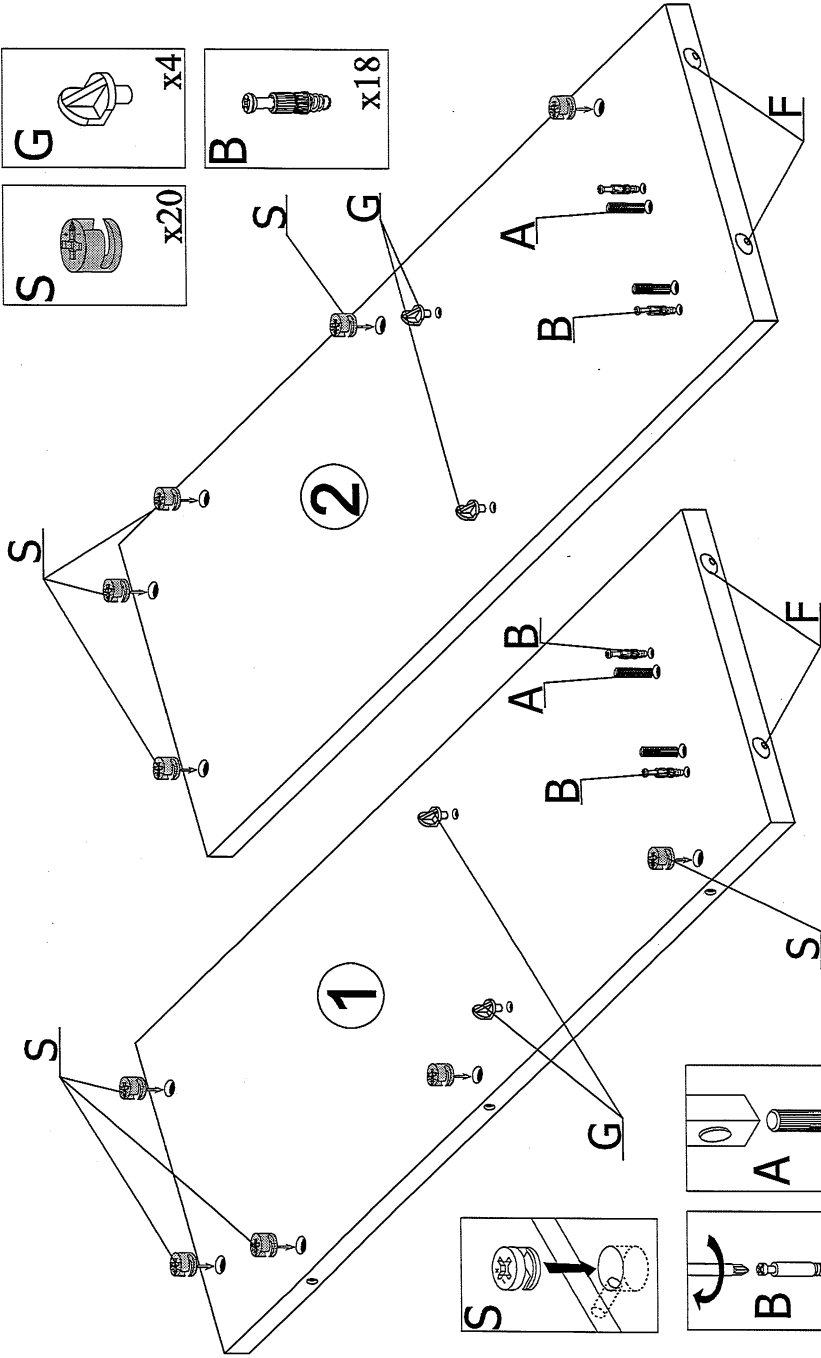

3

3

4

CAN CAN Kommode 2

Nr 3/8

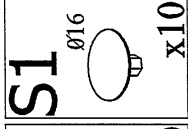
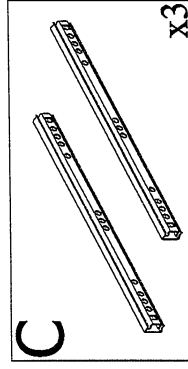
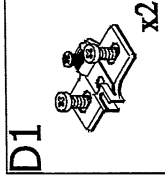
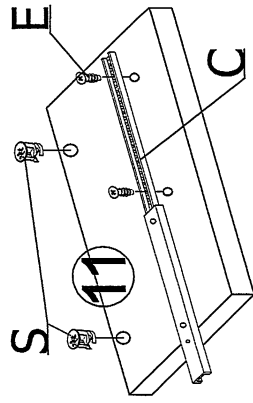
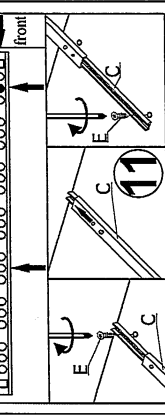
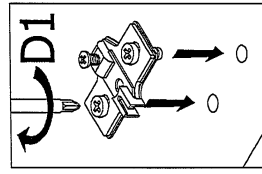
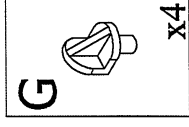
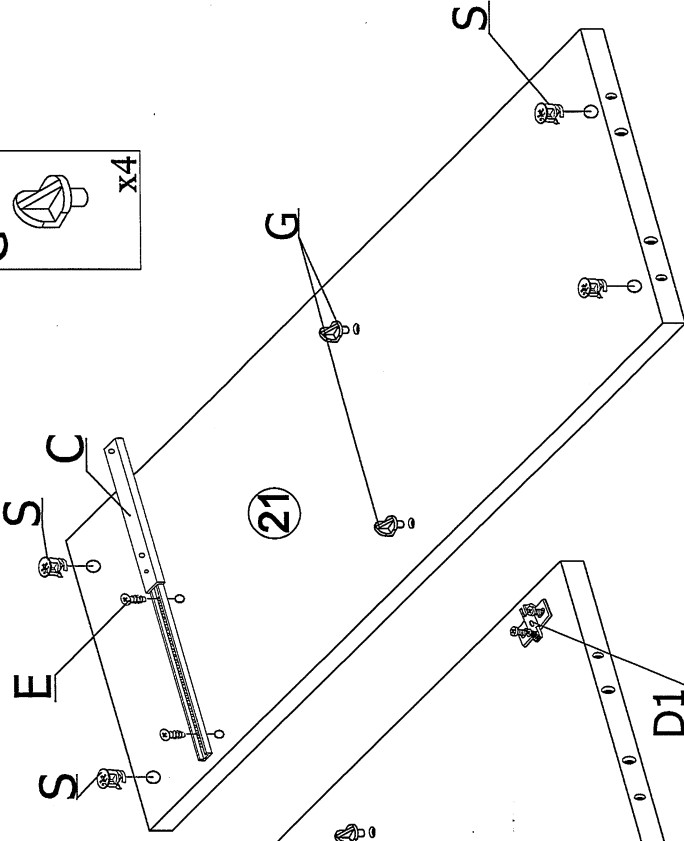
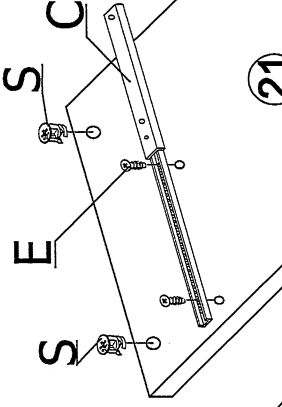
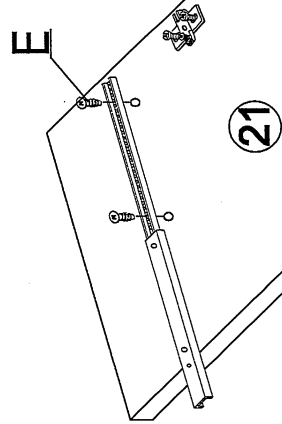
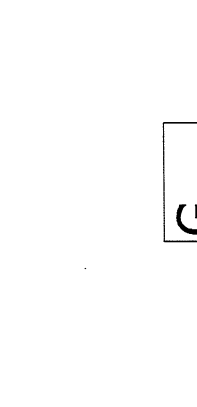
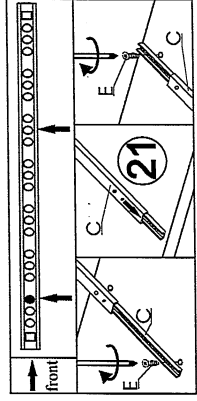
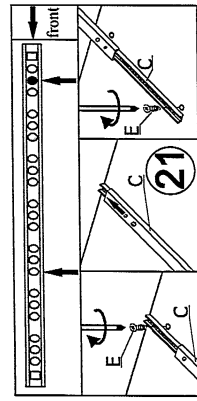
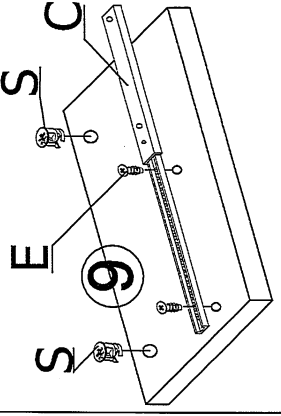
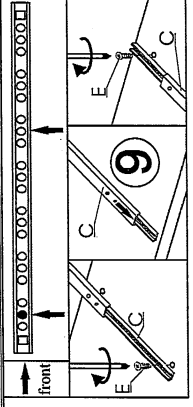
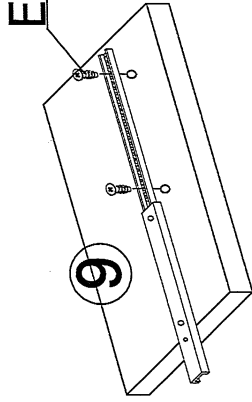
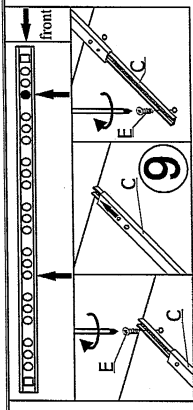
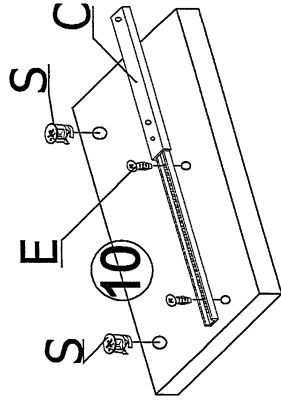
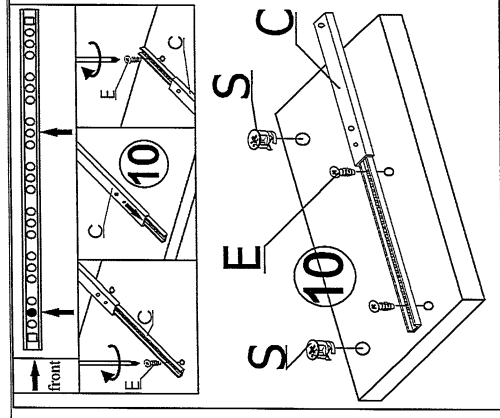

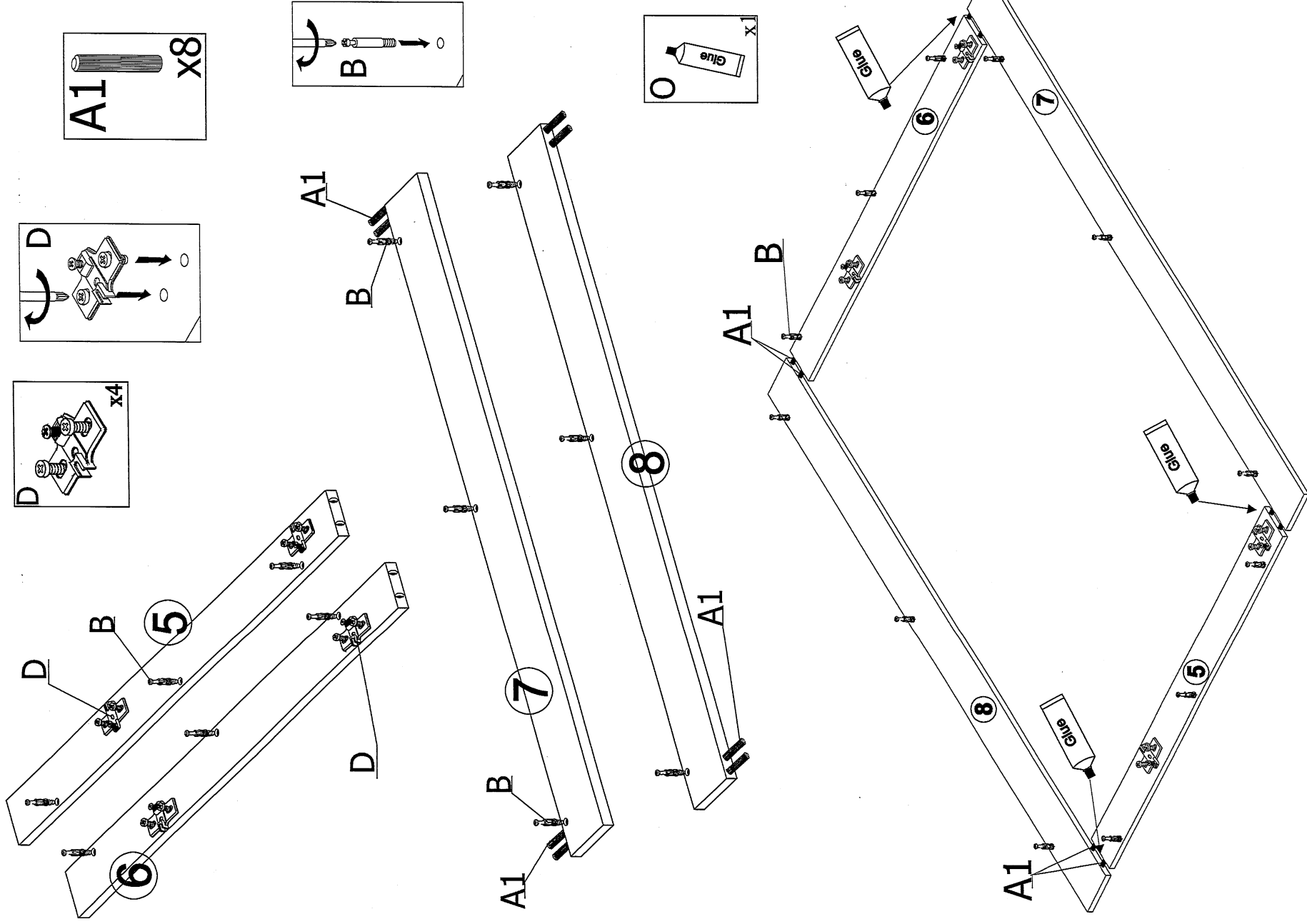

CAN CAN Kommode 2

Nr 5/8

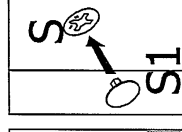
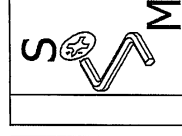
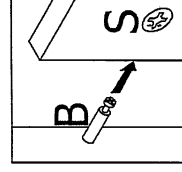
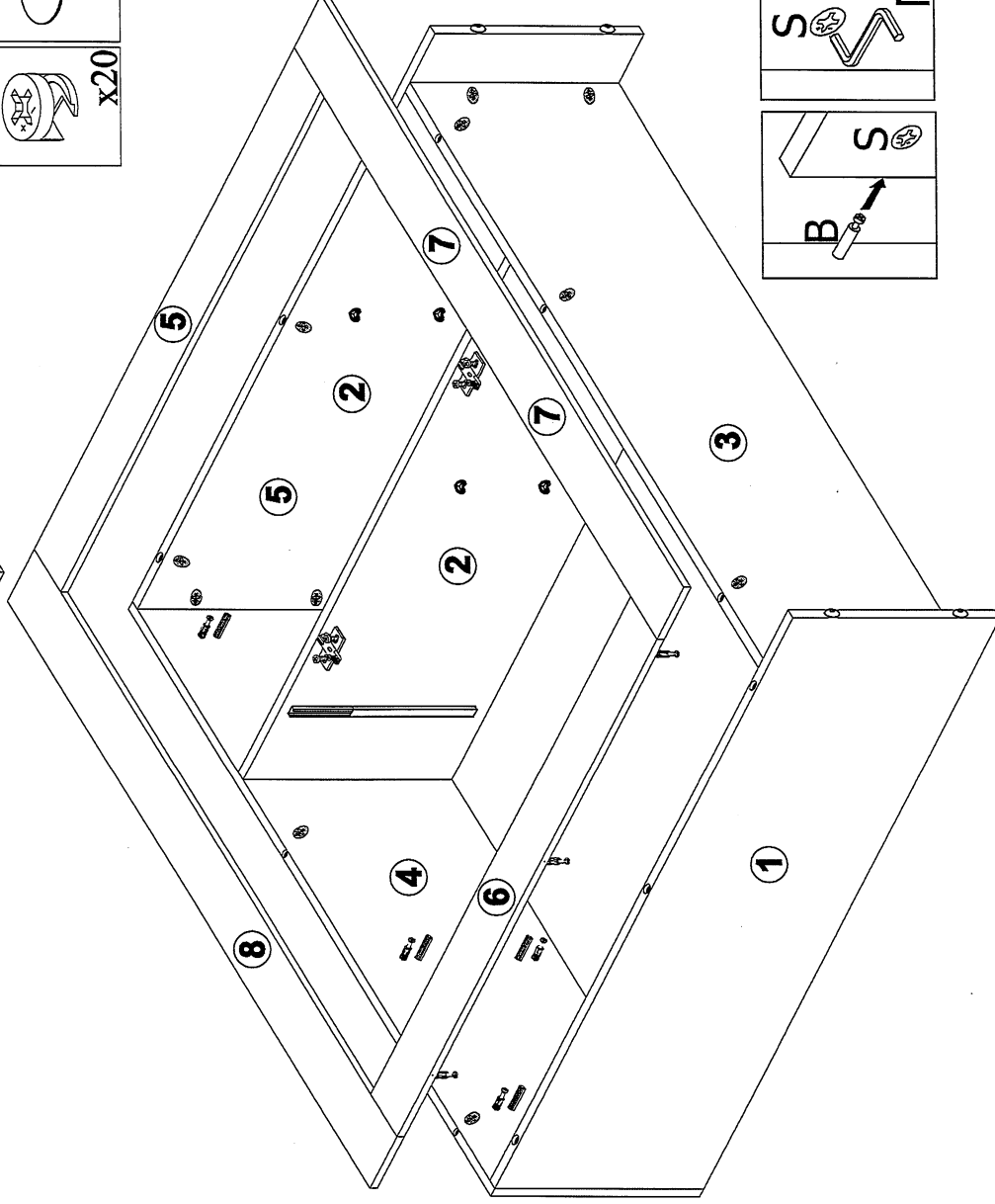
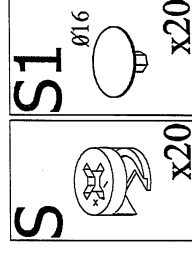
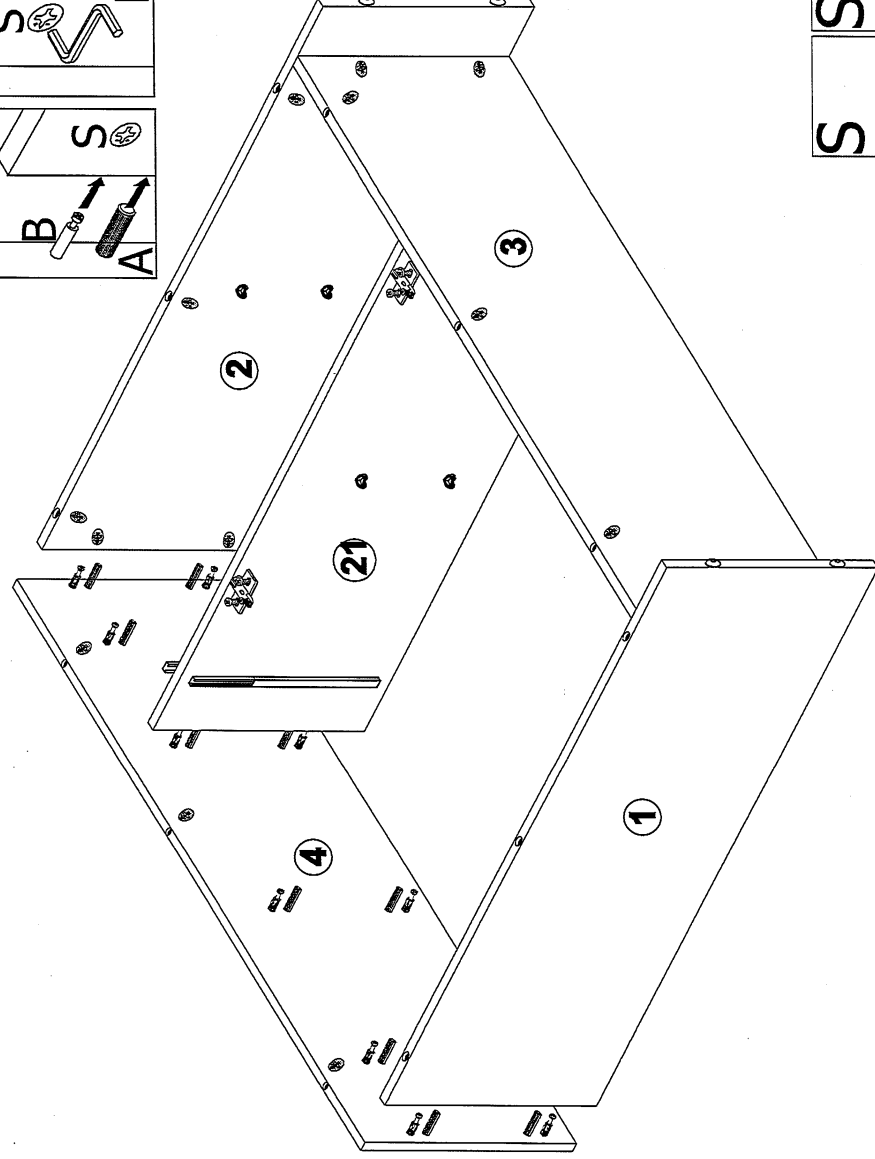
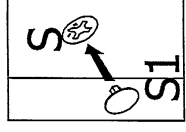
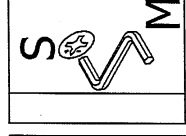
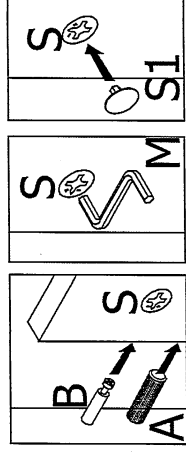

CAN CAN Kommode 2

Nr 6/8

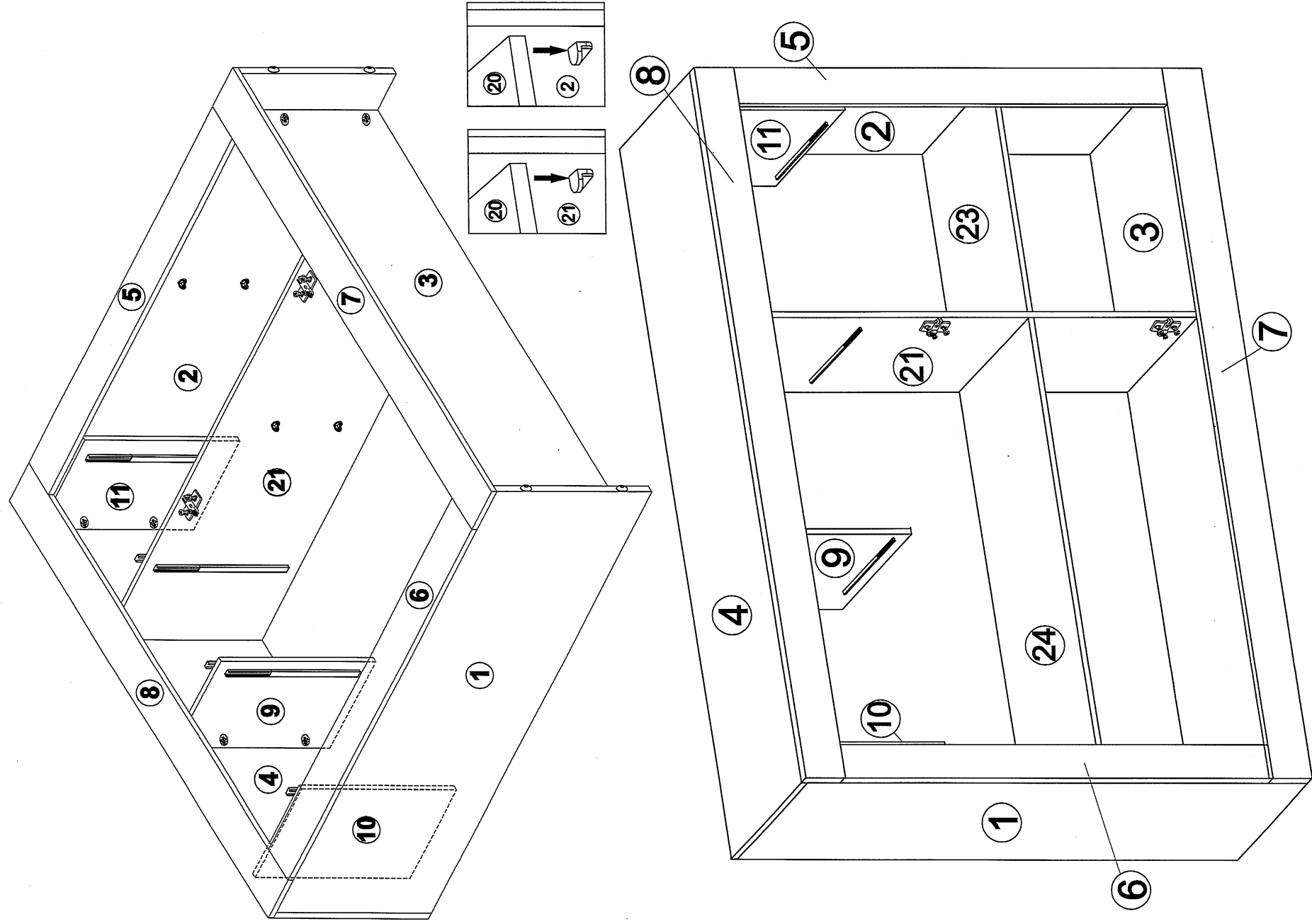

CAN CAN Kommode 2

Nr 7/8

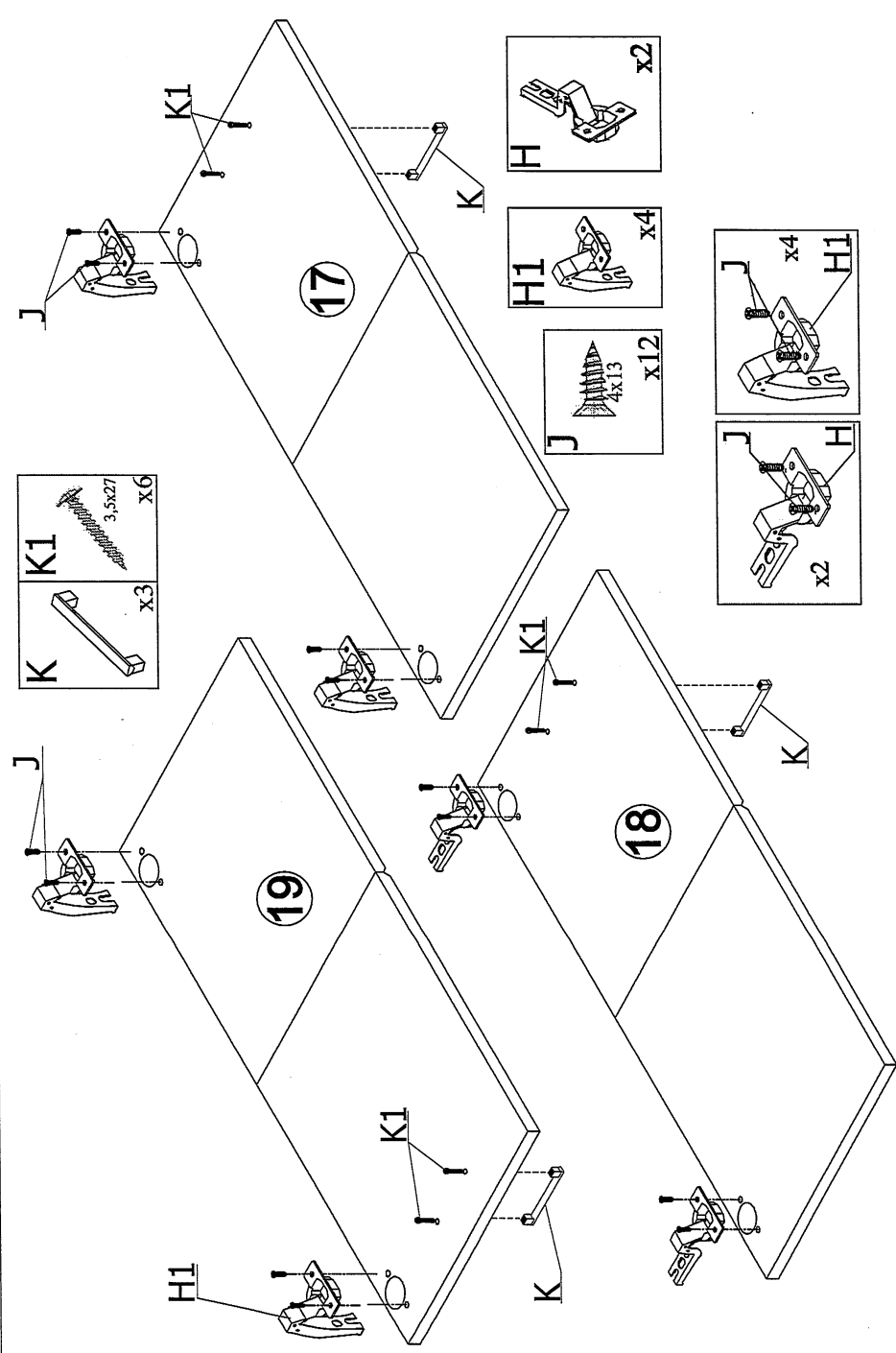
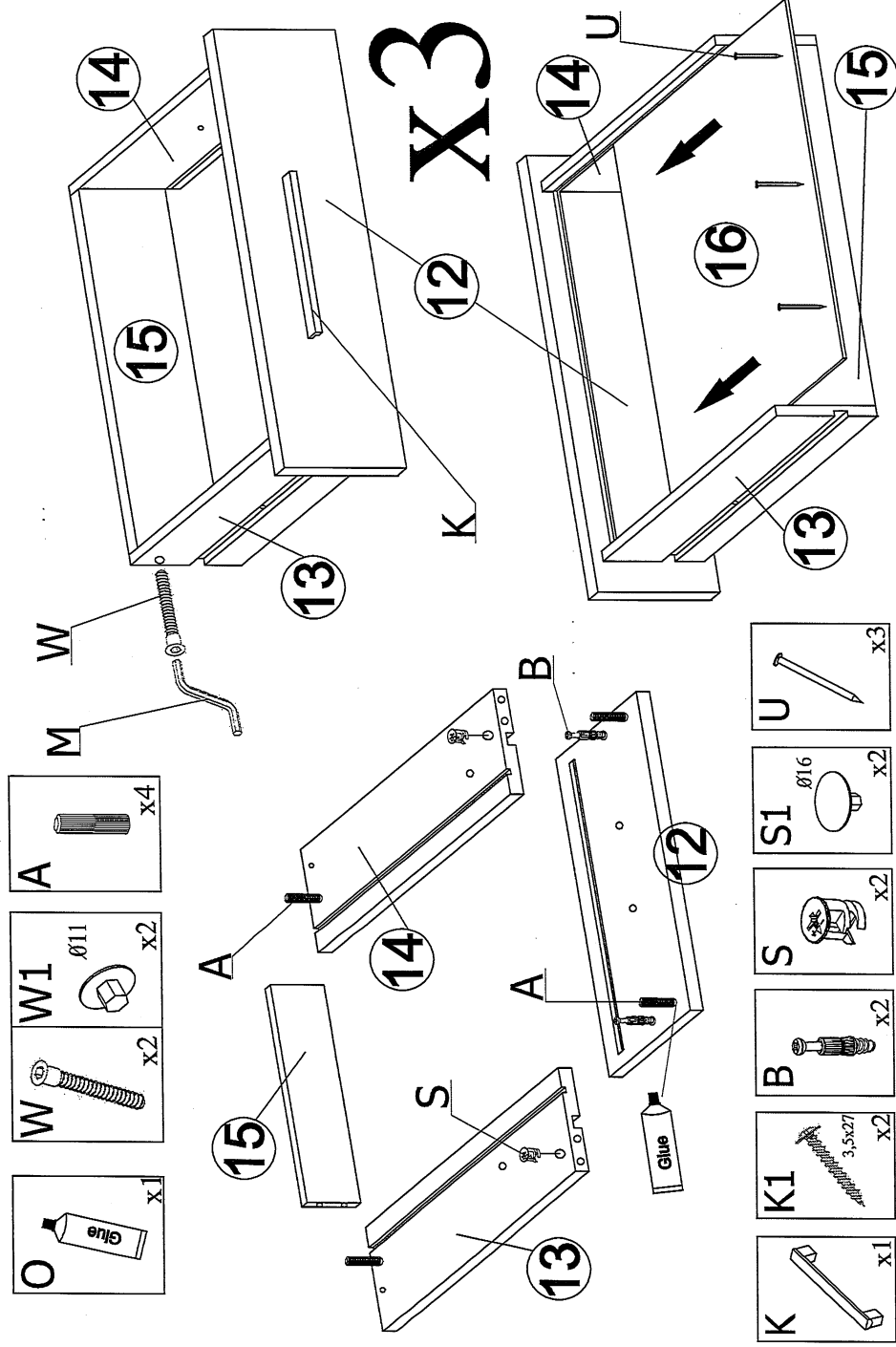

CAN CAN Kommode 2

Nr 8/8

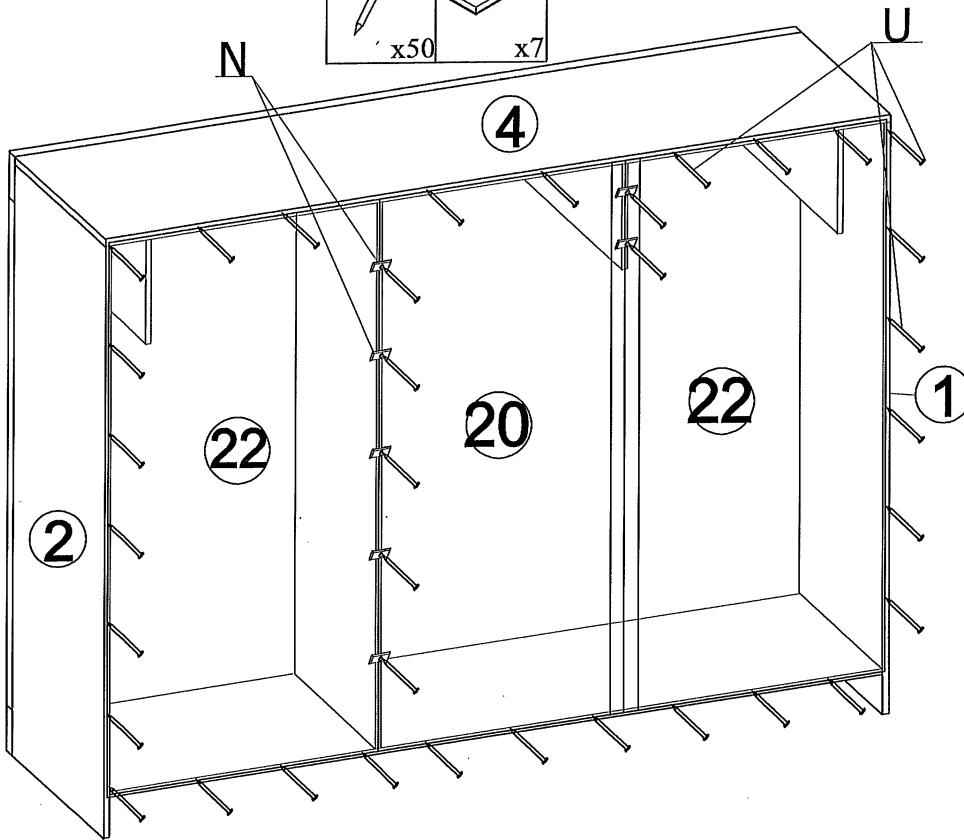
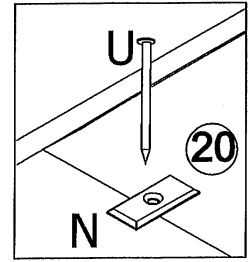
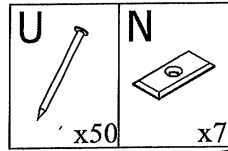

TEILNUMMER	TEILMAß	MENGE	COU
①	864x350x16	1	2/2
②	864x350x16	1	2/2
③	1137x350x16	1	1/2
④	1170x353x16	1	1/2
⑤	760x60x16	1	1/2
⑥	760x60x16	1	1/2
⑦	1171x60x16	1	1/2
⑧	1171x60x16	1	1/2
⑨	200x350x16	1	1/2
⑩	200x350x16	1	1/2
⑪	200x350x16	1	1/2
⑫	150x346x16	3	2/2
⑬	310x110x16	3	1/2
⑭	310x110x16	3	1/2
⑮	293x84x16	3	2/2
⑯	335x318x3	3	1/2
⑰	600x346x16	1	2/2
⑱	600x346x16	1	2/2
⑲	600x346x16	1	2/2
⑳	826x404x3	2	1/2
㉑	804x350x16	1	2/2
㉒	826x354x3	1	1/2
㉓	385x350x16	1	1/2
㉔	735x350x16	1	1/2

